

**Films High-tech adhésifs**

Électrique & Confidentialité	p 4
Anti buée & Anti ondes	p 5

**Films Occultants**

Dépolis	p 6
Opaques de couleurs	p 9
Miroir sans tain	p 10
Occultation spécifique	p 12

**Films Solaires**

Anti chaleur métallisés Intérieur & Extérieur	p 13
Anti chaleur métallisés Argent	p 14
Anti chaleur discret	p 16
Anti chaleur de couleur	p 17
Solaire spécifiques	p 18
Informations techniques	p 20
Anti UV	p 22

**Films Sécurité adhésifs**

Protection de la personne	p 23
Retardateur d'effraction	p 24
Spécifiques & Anti Graffiti	p 25

**Miroiterie**

Film de sécurisation & Dos de Miroir	p 26
Pochoir	p 27
Film pour verre laqué	p 28
Masquage	p 29

**Accessibilité adhésif**

S-Protect	
<i>Soubassement de porte & Protection poignée</i>	p 30
<i>Protection verticale</i>	p 31
Bandes de visualisation	p 32
Bandes Anti Dérapantes	p 34
Bandes de Signalisation	p 36
Bandes de marquage au sol	p 37
Pochoirs	p 38
Signalétique Intérieur & Extérieur	p 40

**Films Tableaux**

Effaçable à sec & Ardoise	p 42
Film métaux ferreux & Film écran	p 43

**Stores**

Vénitiens	p 44
À enroulement	p 46
À lames verticales	p 48
Toiles (Paris & Black-Out)	p 50

**Films automobiles**

Films automobiles	p 52
-------------------	------

**Les Covering Bâtiment**

Présentation	p 53
HomeStar Unie	p 54
Paillettes	p 56
Bois	p 58
Murs	p 60
Déco	p 62
Sublim Bois	p 64
Métal	p 70
Pierre	p 72
Marbre	p 74
Cuir	p 76

**Les Décoratifs pour vitrage**

Les Films Excellence	p 78
4D	p 80
Nature	p 86
Courbes	p 97
Vintage	p 104
Abstraits	p 108
Techniques	p 115
Urbains	p 116
Géométriques	p 117
Carrés	p 124
Ombrine & Veni	p 128
Bandes	p 129
Dégressifs	p 134
Verres	p 139
Concret	p 140
Les Duo Fenêtre	p 141
Les Glass Wall	p 148
Les Vitrostatiques	p 149

**La Personnalisation**

Décoration et marquage	p 150
------------------------	-------

**Accessoires & pose**

Accessoires	p 153
Principes de pose	p 154



DEP SWITCH : l'occultation sur commande

Le **DEP SWITCH** apporte une discrétion à la demande grâce à sa technologie qui permet d'activer/désactiver l'occultation par une simple télécommande ou un interrupteur. Il est conseillé pour les cloisons vitrées d'intérieur. Livré avec transformateur et télécommande.

Livré sur mesure, n'hésitez pas à nous contacter !

DEP SWITCH



Film télécommandé

152 cm
 1 à 3 ml

Film à commande électrique
 De transparent à opacifiant blanc

Pose sur verre et verre synthétique

Informations utiles :

- Tension et fréquence : 220 V / 50 Hertz
- Consommation électrique : ~ 7 Watts / m²
- Temps de réaction 45 ms
- Alimentation par transfo 220 V



CONFIDENTIALITÉ

Secret 333 : Film Anti Espion

Le film **SECRET 333** s'assure que l'écran de votre ordinateur, de votre téléphone ou même de votre tablette ne soient visibles que pour la ou les personnes présentes dans la pièce. Les personnes derrière la vitre verront votre bureau et des écrans noirs, ainsi vous pourrez utiliser vos appareils en toute confidentialité.

SECRET 333



Protection ciblée

152 cm
 1 à 30 ml

Pose sur verre et verre synthétique





DPL 300 : réduit la formation de buée

Le DPL 300 est un film invisible qui permet de retarder la formation de buée, permettant ainsi d'avoir une meilleure visibilité et réduire les traces de calcaire.

Le traitement spécifique de ce film permet ainsi de garder vos vitres et vitrines transparentes. Ce film est idéal dans les milieux humides, tels que les salles de bains (vitres de douches), les piscines, les vitres de fleuristes...

En plus d'avoir l'effet anti buée celui-ci contient également une protection UV, protégeant vos intérieurs d'habitation, vos magasins contre la décoloration. Nous vous conseillons de réaliser un test avant de le commander.



DPL 300
Film anti buée

Zen
PRESTIGE
LONGÉVITÉ RENFORCÉE

152 cm 1 à 30 ml

+ Son traitement permet de diminuer la formation de buée

POLYESTER MULTI 100µ **NON FEU**

Pose sur verre et verre synthétique*

10 ANS GARANTIE

Icons: Home, 10 ANS, UV, Rain, Frost, FE



Films High-tech adhésifs

ANTI ONDES

Protège des ondes

Les films FARAD 285 sont des films de protection pour vitrage contre les ondes électromagnétiques et radioélectriques avec une légère teinte couleur cuivre. Ils s'appliquent en pose intérieure sur du simple vitrage.

Atténuation dB	MHz	%
400 MHz	22,3	92,3
800 MHz	22,2	92,2
900 MHz	20,9	91,0
1800 MHz	16,5	85,0



FARAD 285
Film Anti ondes

Zen
PRESTIGE
LONGÉVITÉ RENFORCÉE

152 cm 1 à 30 ml

POLYESTER MULTI 60µ

Pose sur verre et verre synthétique*

10 ANS GARANTIE

Icons: Home, 10 ANS, UV, Rain, Frost, FE

FARAD 285X
Film Anti ondes

Zen
PRESTIGE
LONGÉVITÉ RENFORCÉE

152 cm 1 à 30 ml

POLYESTER MULTI 60µ

Pose sur verre et verre synthétique*

3 ANS GARANTIE

Icons: Home, 3 ANS, UV, Rain, Frost, FE

Il permet de réduire de façon remarquable les ondes électromagnétiques.



DEP 75



Film dépoli acide

 137 cm	 1 à 25 ml	+ Occultation naturelle + Pose facile
 		
Pose sur verre et verre synthétique*		
		
		

Ce film d'occultation a pour effet de masquer les regards en laissant rentrer le maximum de lumière. D'une intimité quasi-totale, ce film est conseillé pour les vestiaires, salles de bains...



DEP 126



Film dépoli sablé

 75-122 -152 cm	 1 à 25 ml	+ Polyvalent + Garantie 5 ans en extérieur
 		
Pose sur verre et verre synthétique*		
		
		











Tout en conservant un aspect dépoli naturel, il apporte une très forte occultation. Il est conseillé pour les bureaux et salle de bains.



DEP 127



Film dépoli sablé pailleté

 75-122 -152 cm	 1 à 25 ml	+ Élégance + Longévité
 		
Pose sur verre et verre synthétique*		
		
		

Ce film en PVC polymère longue durée **auto-cicatrisant**, est d'aspect dépoli sablé offrant une forte occultation avec des incrustations légères de paillettes. En plus d'être très esthétique, il vous protégera efficacement des regards extérieurs.



DEP 20



Film dépoli blanc

 75-122-152 -182 cm	 1 à 30 ml	+ Occultation intense + Teinte blanche
 		
Pose sur verre et verre synthétique*		
		
		











Avec une teinte dépoli blanc, il a une occultation puissante. Il convient pour les zones de confinement des écoles, les salles de bains, vestiaires, salle d'eau...



DEP 600



Film diffusant

 137 cm	 1 à 25 ml	+ Opacifiant + Diffusant la lumière
 		
Pose sur verre et verre synthétique*		
		
		

Avec une occultation extrême. Il est spécialement conçu pour masquer les objets ou les gens juste derrière le verre. Idéal pour les zones de confinement des écoles, les vitrines avec du mobilier derrière, des vestiaires avec un faible recule...



*Toujours se référer au DTU 39



DEP 145 *La gamme pro Classique*

Film dépoli acide

152 cm	1 à 25 ml	+ Non teinté	+ Intérieur	PVC 10µ	NON FEU
--------	-----------	--------------	-------------	---------	---------

Pose sur verre et verre synthétique*

10 ANS GARANTIE

Icons: Home, Sun, Hammer, Screwdriver, Snowflake

GP ACIDE *GP Films*

Film dépoli acide

152 cm	5 à 30 ml par tranche de 5m	+ 1 ^{er} prix		PVC 80µ	NON FEU
--------	-----------------------------	------------------------	--	---------	---------

Pose sur verre et verre synthétique*

5 ANS GARANTIE

Icons: Home, Sun, Hammer, Screwdriver, Snowflake

Ces films d'occultation ont pour effet de masquer les regards en laissant rentrer le maximum de lumière. D'une intimité quasi-totale, ces films sont conseillés pour les vestiaires, salles de bains...



DEP 256 *La gamme pro Classique*

Film dépoli sablé

50-105 155 cm	1 à 25 ml	+ Qualité/Prix	+ Intérieur / extérieur	PVC 80µ	NON FEU
------------------	-----------	----------------	-------------------------	---------	---------

Pose sur verre et verre synthétique*

10 ANS GARANTIE

3 ANS GARANTIE

Icons: Home, Sun, Hammer, Screwdriver, Snowflake

GP SABLE *GP Films*

Film dépoli sablé

152 cm	5 à 25 ml par tranche de 5m	+ 1 ^{er} Prix	+ Intérieur	PVC 75µ	NON FEU
--------	-----------------------------	------------------------	-------------	---------	---------

Pose sur verre et verre synthétique*

5 ANS GARANTIE

Icons: Home, Sun, Hammer, Screwdriver, Snowflake

Tout en conservant un aspect dépoli naturel, ils apportent une très forte occultation. Ils sont conseillés pour les bureaux et salle de bains.



DEP BL *La gamme pro Classique*

Film dépoli blanc

75-122 152 cm	1 à 30 ml	+ Qualité/Prix	+ Teinte blanche	POLYESTER 50µ	NON FEU
------------------	-----------	----------------	------------------	---------------	---------

Pose sur verre et verre synthétique*

10 ANS GARANTIE

Icons: Home, Sun, Hammer, Screwdriver, Snowflake

GP OPAL *GP Films*

Film dépoli blanc

152 cm	5 à 30 ml par tranche de 5m	+ 1 ^{er} Prix	+ Teinte opale	POLYESTER 96µ	NON FEU
--------	-----------------------------	------------------------	----------------	---------------	---------

Pose sur verre et verre synthétique*

5 ANS GARANTIE

Icons: Home, Sun, Hammer, Screwdriver, Snowflake

Avec une teinte dépoli blanc, ils ont une occultation puissante. Ils conviennent pour les salles de bains, vestiaires, salle d'eau...



Films vinyles teintés dans la masse pour opacifier, recouvrir, décorer et habiller vos vitrages, vos meubles, crédances, toutes surfaces lisses et bloquées.



Pour une pose sur des vitrages exposés directement au soleil, bien respecter le DTU 39 (vous pouvez nous consulter).



OPAC 600 

Film opaque de couleur

122 cm 1 à 25 ml

Longévité
Intérieur & Ext.

POLYMÈRE 75µ NON FEU

Pose sur verre et verre synthétique*

10 ANS GARANTIE

5 ANS GARANTIE

Icons: Home, Question mark, Hammer, Wrench, No fire

Film polymère longue durée, proposé dans un choix de 31 couleurs, utilisable en intérieur ou extérieur, en grande ou petite dimension.

610	672 RAL 7035	675 RAL 7042	673 RAL 7024	670 RAL 9017	680 RAL 8011	625 RAL 1016	621 RAL 1021	620 RAL 1037	633 RAL 2009	632 RAL 3028
631	630 RAL 3003	631-2 RAL 3004	645	641 RAL 4010	646 RAL 4005	665 RAL 5013	649 RAL 5002	648 RAL 5010	647 RAL 5015	653
666 RAL 5018	664 RAL 6018	662 RAL 6037	661 RAL 6026	623 RAL 1014	690 argent	691 or	692 cuivre	694 anthracite		



OPAC 500 

Film opaque de couleur

122 cm 1 à 25 ml

Qualité/Prix
Intérieur

PVC 80µ NON FEU

Pose sur verre et verre synthétique*

10 ANS GARANTIE

Icons: Home, Question mark, Hammer, Wrench, No fire

Film PVC pour usage intérieur, proposé en 11 coloris.

510	575 RAL 7042	570 RAL 9017	521 RAL 1021	532 RAL 3028	541 RAL 4010	565 RAL 5013	556	561 RAL 6026	523 RAL 1014	590 argent
-----	-----------------	-----------------	-----------------	-----------------	-----------------	-----------------	-----	-----------------	-----------------	---------------



OPAC 400 

Film opaque de couleur

155 cm 5 à 25 ml par tranche de 5m

1^{er} prix
Intérieur

PVC 80µ NON FEU

Pose sur verre et verre synthétique*

5 ANS GARANTIE

Icons: Home, Question mark, Hammer, Wrench, No fire

Film monomère blanc pour usage intérieur, au meilleur prix.

410

*Toujours se référer au DTU 39
Les RAL sont annoncés à titre indicatif l'équivalence n'est pas trictée

Les Miroirs : voir sans être vu

Le film miroir sans tain permet de voir sans être vu, en fonction du basculement de lumière. Ainsi du côté le plus lumineux vous aurez un miroir parfait et du côté le plus sombre une vitre teintée. La nuit tombante avec une forte lumière, l'effet à tendance à s'inverser.



MIROIR XO



Intérieur Extérieur

Film miroir sans tain pour l'intérieur et l'extérieur

75-122-152 cm 1 à 30 ml

POLYESTER MULTI 5μ NON FEU

Pose sur verre et verre synthétique*

12 ANS GARANTIE

10 ANS GARANTIE

- + Grande longévité
- + Métallisation renforcée
- + Intérieur/Extérieur
- + Réduction de l'éblouissement : 83%

Les films miroir sans tain argent avec une métallisation renforcée et en polyester nouvelle génération renforcé en traitement UV, pour un meilleure longévité. Idéal également pour réduire l'éblouissement.



MIROIR 50

Film miroir sans tain argent

75-122-152-183 cm 1 à 30 ml

+ Réduction de l'éblouissement : 79%

POLYESTER MULTI 60μ NON FEU

Pose sur verre et verre synthétique*

10 ANS GARANTIE

Les films miroir sans tain métallisés argent en polyester Cristal+ facilitant la manipulation et la pose.

MIROIR 50X

Film miroir sans tain argent

75-122-152-183 cm 1 à 30 ml

+ Réduction de l'éblouissement : 84%

POLYESTER 75μ NON FEU

Pose sur verre et verre synthétique*

7 ANS GARANTIE



MIROIR NEUTRE

Film miroir sans tain gris

152 cm 1 à 30 ml

+ Réduction de l'éblouissement : 78%

POLYESTER MULTI 60μ NON FEU

Pose sur verre et verre synthétique*

10 ANS GARANTIE

Avec une teinte grise, ils vous apportent les avantages d'un miroir sans tain avec la métallisation atténuée visuellement pour être plus discret.

MIROIR NEUTRE X

Film miroir sans tain gris

152 cm 1 à 30 ml

+ Réduction de l'éblouissement : 75%

POLYESTER 75μ NON FEU

Pose sur verre et verre synthétique*

3 ANS GARANTIE

*Toujours se référer au DTU 39



MIROIR

la gamme pro
Classique

Film miroir sans tain argent

75-122 -152 cm 1 à 30 ml **Qualité/Prix**

Pose sur verre et verre synthétique*

MIROIR X

la gamme pro
Classique

Film miroir sans tain argent

75-122 -152 cm 1 à 30 ml **Qualité/Prix**

Pose sur verre et verre synthétique*

Les films miroir sans tain argent, vous permettent de vous protéger des regards tout en vous laissant une vision vers l'extérieur la journée.



MIR-AGN

GP
Films pour vitrage

Film miroir sans tain argent

152 cm 5 à 30 ml par tranche de 5m **1^{er} Prix**

Pose sur verre et verre synthétique*

MIR-AGNX

GP
Films pour vitrage

Film miroir sans tain argent

152 cm 5 à 30 ml par tranche de 5m **1^{er} Prix**

Pose sur verre et verre synthétique*

Les films miroir sans tain argent, vous permettent de vous protéger des regards tout en vous laissant une vision vers l'extérieur la journée.



INTÉRIEUR SANS



INTÉRIEUR AVEC



EXTÉRIEUR SANS



EXTÉRIEUR AVEC

*Toujours se référer au DTU 39

Zen
PRESTIGE Réservée aux Meilleurs
LONGÉVITÉ RENFORCÉE



MIROIR 80

152 cm 1 à 30 ml

+ Réduction de l'éblouissement 90%

POLYESTER MULTI 60µ NON FEU

Pose sur verre et verre synthétique*

10 ANS GARANTIE

Icons: Home, 10 ANS GARANTIE, Vertical lines, No hammer, No fire, No Fe.

MIROIR 80 X

152 cm 1 à 30 ml

+ Réduction de l'éblouissement 90%

POLYESTER MULTI 75µ NON FEU

Pose sur verre et verre synthétique*

5 ANS GARANTIE

Icons: Sun, 5 ANS GARANTIE, Vertical lines, Hammer, No fire, No Fe.

Miroir «sélectif» Couleur Métal à l'extérieur et Bleu nuit côté colle.



OPAC MIROIR

152 cm 1 à 30 ml

+ Aspect miroir

POLYESTER MULTI 60µ M1

Pose sur verre et verre synthétique*

10 ANS GARANTIE

Icons: Home, 10 ANS GARANTIE, Vertical lines, No hammer, No fire, No Fe.

Film effet miroir argent opaque en polyester métallisé permet l'occultation complète d'un vitrage en apportant un aspect miroir de grande qualité des deux côtés. Conçu pour des effets décoratifs de grande qualité. Idéal pour des vitres en cloisons.

Zen la gamme Réservée aux Meilleurs

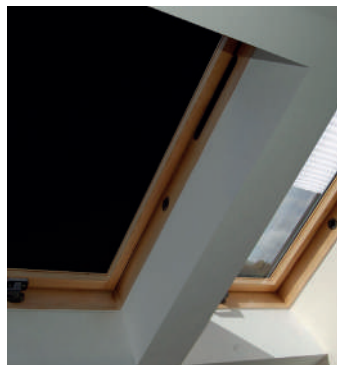

BL OUT

120 cm 1 à 25 ml

+ Film black out 99%

+ Noire/Colle Blanche

POLYMERÉ 160µ

Pose sur verre et verre synthétique*

10 ANS GARANTIE

Icons: Home, 10 ANS GARANTIE, Vertical lines, Hammer, No fire, No Fe.

BL OUT X

120 cm 1 à 25 ml

+ Film black out 99%

+ Blanc/Colle Noire

POLYMERÉ 160µ

Pose sur verre et verre synthétique*

5 ANS GARANTIE

Icons: Sun, 5 ANS GARANTIE, Vertical lines, Hammer, No fire, No Fe.

Avec le BL OUT vous obtiendrez la nuit noire en plein jour, là où un film opaque laisserait passer encore beaucoup de luminosité. Idéal pour dortoir, cinéma, école, crèche...

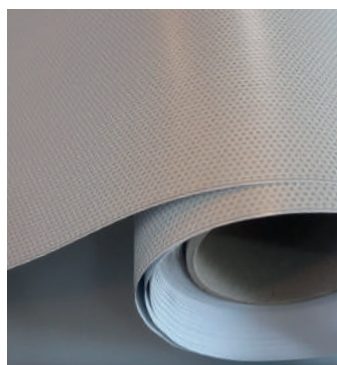

MIC BL

150 cm 1 à 25 ml

+ 70/30 : rapport film/trou

POLYMERÉ 120µ

Pose sur verre et verre synthétique*

3 ANS GARANTIE

Icons: Sun, 3 ANS GARANTIE, Vertical lines, Hammer, No fire, No Fe.



Le MIC BL permet de voir sans être vu. Composé de 2 faces micro perforées, l'une blanche et l'autre noire, il permet de voir de l'intérieur (coté noir) vers l'extérieur (coté blanc). Attention avec un delta de luminosité trop important (comme de nuit avec une forte lumière) l'effet à tendance à s'inverser.

*Toujours se référer au DTU 39

Un film pour **2** applications

Ces films anti chaleur très haute performance, protègent efficacement de la chaleur et des UV provocants la décoloration. Réduisent l'éblouissement. Ils se posent aussi bien à l'intérieur qu'à l'extérieur selon le type de vitrage.

GARANTIE

des films en pose verticale

12
ANS

Intérieur

10
ANS

Extérieur















Réservée aux Meilleurs



MULTI 080

Film solaire Int / Ext











 75-122 152 cm	 1 à 30 ml	<ul style="list-style-type: none"> + Film anti chaleur 86% + Métallisation renforcée 	
 			
Pose sur verre et verre synthétique*			
			
			

Film anti chaleur **haute performance**, de nouvelle génération. Pose intérieure ou extérieure en fonction du vitrage.



MULTI 070

Film solaire Int / Ext











 75-122 152 cm	 1 à 30 ml	<ul style="list-style-type: none"> + Film anti chaleur 72% + Semi métallisation 	
			
Pose sur verre et verre synthétique*			
			
			

Film anti chaleur **équilibré** entre efficacité et clarté. Pose intérieure ou extérieure en fonction du vitrage.



MULTI 050

Film solaire Int / Ext

 75-122 152 cm	 1 à 30 ml	<ul style="list-style-type: none"> + Film anti chaleur 55% + Faible métallisation 	
			
Pose sur verre et verre synthétique*			
			
			

Film anti chaleur **lumineux** qui apporte une atténuation remarquable de la chaleur. Pose intérieure ou extérieure en fonction du vitrage.

*Toujours se référer au DTU 39



SOL 080

Film solaire performance

75-122-152 -183 cm
 1 à 30 ml
 + Film anti chaleur 79%

Pose sur verre et verre synthétique*

Film anti chaleur , protège efficacement de la chaleur et des UV provocants la décoloration. Réduit l'éblouissement. Idéal pour véranda, verrière, fenêtre de toit...

SOL 080X

Film solaire performance

75-122-152 -183 cm
 1 à 30 ml
 + Film anti chaleur 87%

Pose sur verre et verre synthétique*



SOL 065

Film solaire équilibre

75-122 152 cm
 1 à 30 ml
 + Film anti chaleur 68%

Pose sur verre et verre synthétique*

Film anti chaleur proposant un **équilibre entre performance et clarté**. Un compromis idéal pour les fenêtres de bureau, d'appartement, de maison...

SOL 065X

Film solaire équilibre

75-122 152 cm
 1 à 30 ml
 + Film anti chaleur 61%

Pose sur verre et verre synthétique*



SOL 050

Film solaire

75-122 152 cm
 1 à 30 ml
 + Film anti chaleur 58%

Pose sur verre et verre synthétique*

Films anti chaleur **très lumineux**. Ils apportent une bonne protection en conservant le maximum de clarté.

SOL 050X

Film solaire

75-122 152 cm
 1 à 30 ml
 + Film anti chaleur 56%

Pose sur verre et verre synthétique*

La réduction de luminosité avec la teinte neutre :

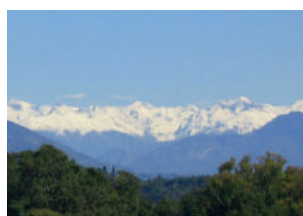

Réduction éblouissement 0%

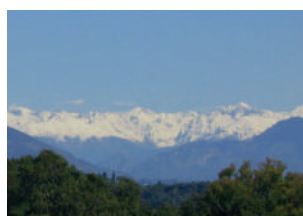

Réduction éblouissement 55%

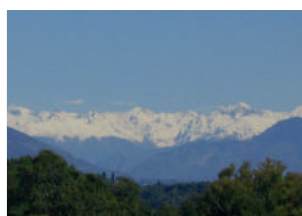

Réduction éblouissement 70%

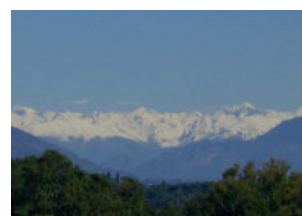

Réduction éblouissement 80%

*Toujours se référer au DTU 39

la gamme pro
Classique La Qualité, le Prix, sans compromis



SUN 80

Film solaire 79%

 75-122 -152 cm 1 à 30 ml

+ Teinte argent

POLYESTER 50μ **NON FEU**

Pose sur verre et verre synthétique*



SUN 80X

Film solaire 80%

 75-122 -152 cm 1 à 30 ml

+ Teinte argent

POLYESTER 60μ **NON FEU**

Pose sur verre et verre synthétique*



Films anti chaleur forte protection. Ils vous protègent de la chaleur et des UV.



SUN 65

Film solaire équilibre

 152 cm 1 à 30 ml

+ Film anti chaleur 65%

POLYESTER 50μ **NON FEU**

Pose sur verre et verre synthétique*



SUN 65X

Film solaire équilibre

 152 cm 1 à 30 ml

+ Film anti chaleur 65%

POLYESTER 60μ **NON FEU**

Pose sur verre et verre synthétique*



Film anti chaleur équilibré entre anti chaleur et une certaine conservation de la luminosité. Conseillés pour les fenêtres de bureau, d'appartement, de maison...

GP  **Films pour vitrage** **Le 1^{er} Prix**



SIL 80

Film solaire 79%

 152 cm 5 à 30 ml par tranche de 5m

+ Teinte argent

POLYESTER 56μ **NON FEU**

Pose sur verre et verre synthétique*



SIL 80X

Film solaire 80%

 152 cm 5 à 30 ml par tranche de 5m

+ Teinte argent

POLYESTER μ **NON FEU**

Pose sur verre et verre synthétique*



Films solaires de forte efficacité au meilleur budget.



SIL 70

Film solaire équilibre

 152 cm 5 à 30 ml par tranche de 5m

+ Film anti chaleur 68%

POLYESTER 56μ **NON FEU**

Pose sur verre et verre synthétique*



SIL 70X

Film solaire équilibre

 152 cm 5 à 30 ml par tranche de 5m

+ Film anti chaleur 65%

POLYESTER 46μ **NON FEU**

Pose sur verre et verre synthétique*



Films anti chaleur plus lumineux. Ils apportent une bonne protection en conservant le maximum de clarté au meilleur budget.

*Toujours se référer au DTU 39



Ces films anti chaleur métallisés vous offrent de la discrétion sans négliger la performance. Leur teinte neutre (grisée) apporte un aspect discret à votre vitrage, et réduit l'effet brillant de la métallisation, tout en protégeant efficacement de la chaleur.



SOL 180

Film solaire gris neutre

152 cm 1 à 30 ml

+ Film anti chaleur 61%

POLYESTER MULTI 60µ NON FEU

Pose sur verre et verre synthétique*

10 ANS GARANTIE

Icons: Home, 10 ANS GARANTIE, Blue vertical bar, No reflection, No glare, No heat.

Film anti chaleur allie performance et discrétion grâce à sa teinte grise qui masque la métallisation.

SOL 180X

Film solaire gris neutre

152 cm 1 à 30 ml

+ Film anti chaleur 74%

POLYESTER MULTI 75µ NON FEU

Pose sur verre et verre synthétique*

3 ANS GARANTIE

Icons: Home, 3 ANS GARANTIE, Blue vertical bar, No reflection, No glare, No heat, No fire.



SOL 165

Film solaire gris neutre

152 cm 1 à 30 ml

+ Film anti chaleur 50%

POLYESTER MULTI 60µ NON FEU

Pose sur verre et verre synthétique*

10 ANS GARANTIE

Icons: Home, 10 ANS GARANTIE, Blue vertical bar, No reflection, No glare, No heat.

Film solaire équilibré entre efficacité, clarté et teinte grise discrète.

SOL 165X

Film solaire gris neutre

152 cm 1 à 30 ml

+ Film anti chaleur 65%

POLYESTER MULTI 75µ NON FEU

Pose sur verre et verre synthétique*

3 ANS GARANTIE

Icons: Home, 3 ANS GARANTIE, Blue vertical bar, No reflection, No glare, No heat, No fire.

La réduction de luminosité avec la teinte neutre :

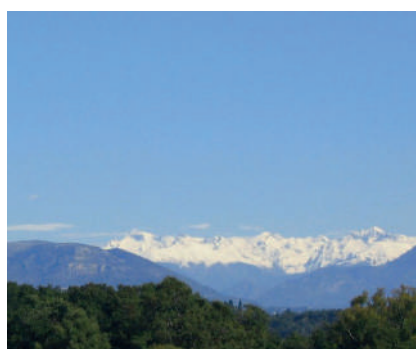

Réduction éblouissement 0%

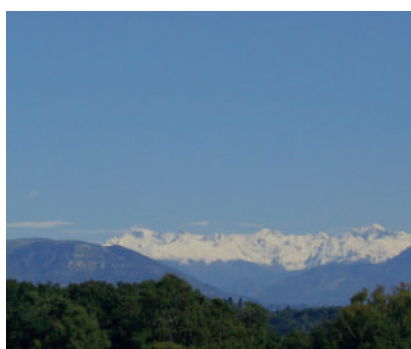

Réduction éblouissement 65%

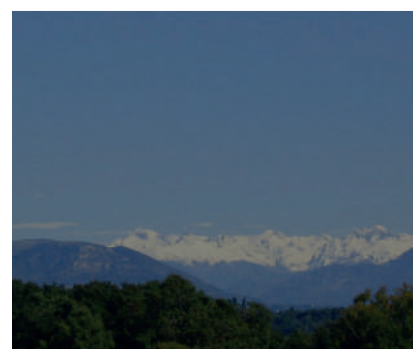

Réduction éblouissement 80%



Les films anti chaleur de couleurs à forte métallisation, protègent efficacement de la chaleur et des UV provocants la décoloration. Réduit l'éblouissement tout en gardant une vision parfaite vers l'extérieur. Apporte de la couleur à vos vitrages.





SOL 280
Film solaire bronze

152 cm 1 à 30 ml

+ Film anti chaleur 76%

POLYESTER MULTI 60µm NON FEU

Pose sur verre et verre synthétique*

Film anti chaleur de couleur bronze, cette métallisation particulière vous apporte un aspect classieux. Il protège efficacement de la chaleur et des UV provocants la décoloration. Il est très efficace contre l'éblouissement.





SOL 280X
Film solaire bronze

152 cm 1 à 30 ml

+ Film anti chaleur 80%

POLYESTER MULTI 75µm NON FEU

Pose sur verre et verre synthétique*





SOL 380
Film solaire bleu

152 cm 1 à 30 ml

+ Film anti chaleur 72%

POLYESTER MULTI 60µm NON FEU

Pose sur verre et verre synthétique*

Film anti chaleur de couleur bleue, cette métallisation particulière vous apporte un aspect bleu azur. Il protège efficacement de la chaleur et des UV provocants la décoloration. Il est très efficace contre l'éblouissement.





SOL 380X
Film solaire bleu

152 cm 1 à 30 ml

+ Film anti chaleur 79%

POLYESTER MULTI 75µm NON FEU

Pose sur verre et verre synthétique*



SOL 480
Film solaire vert

152 cm 1 à 30 ml

+ Film anti chaleur 77%

POLYESTER MULTI 60µm NON FEU

Pose sur verre et verre synthétique*

Film anti chaleur de couleur verte, cette métallisation particulière vous apporte un aspect vert émeraude. Il protège efficacement de la chaleur et des UV provocants la décoloration. Il est très efficace contre l'éblouissement.





SOL 480X
Film solaire vert

152 cm 1 à 30 ml

+ Film anti chaleur 77%

POLYESTER MULTI 75µm NON FEU

Pose sur verre et verre synthétique*

Films Solaires adhésifs : Anti chaleur discret & de couleur

I-SOL 80



Film Anti chaleur
& Anti froid haute efficacité

		+ Rejet chaleur 82%
152 cm	1 à 30 ml	+ Diminution déperdition chaleur 34%
Pose sur verre et verre synthétique*		

I-SOL 50



Film Anti chaleur
& Anti froid équilibré

		+ Rejet chaleur 56%
152 cm	1 à 30 ml	+ Diminution déperdition chaleur 27%
Pose sur verre et verre synthétique*		

-3m²

Les films I-Sol allient **anti chaleur ET anti froid** tout en étant performant et discret.



PHOTOCHROMIQUE



SOL CH70



Film photochromique

		+ Film photochromique
152 cm	1 à 30 ml	+ Adhésif qui se teinte
Pose sur verre et verre synthétique, max 2m ² *		

Le SOL CH70 est un film qui se teinte en bleu, en fonction de l'intensité du Soleil (UV). Ainsi plus le soleil est fort, plus le film sera teinté, et plus il fera nuit, et plus le film s'éclaircira. Ce film est conseillé pour les fenêtres d'habitation, de bureau, et déconseillé pour les grands volumes et baies vitrées.

*Toujours se référer au DTU 39

Ces films anti chaleur performants, quasi invisibles high-tech multi-métallisés permettent, sans dénaturer le vitrage, de conserver de chaque côté de celui-ci, une très bonne visibilité. Ils sont idéals pour les magasins, les musées, les habitations, les sites classés...



SOL 455 X



Film solaire faible métallisation

 75-122 152-183 cm	 1 à 30 ml	+ Film anti chaleur 56%	+ Très lumineuse
Pose sur verre et verre synthétique*			NON FEU
			

Information

Il filtre le spectre du soleil, pour laisser entrer le maximum de luminosité

Ce film a un faible aspect métallisé. Idéal pour des magasins ne souhaitant pas dénaturer leur vitrine. Pose extérieure tout type de vitrage.

Nouvelle Version



SOL 40S



Film solaire quasi invisible

 152 cm	 1 à 30 ml	+ Film anti chaleur 59%	+ Quasi invisible
Pose sur verre et verre synthétique*			NON FEU
			

Ce film a un faible aspect métallisé. Idéal pour des magasins ne souhaitant pas dénaturer leur vitrine.







ANTI CHALEUR TOUT VITRAGE INTÉRIEUR



CÉRAMIQUE 70



Film solaire tout vitrage

 152 cm	 1 à 30 ml	+ Film anti chaleur 66%	+ Réduction éblouissement 52%
Pose sur verre et verre synthétique*			NON FEU
			

Pose intérieure et tout vitrage (moins de 3m², au delà nous consulter)

Film anti chaleur quasi invisible vu de l'intérieur, il filtre le spectre du soleil, pour laisser entrer le maximum de luminosité, en apportant une couleur champagne vue de l'extérieur.

*Toujours se référer au DTU 39

1^{er} Prix

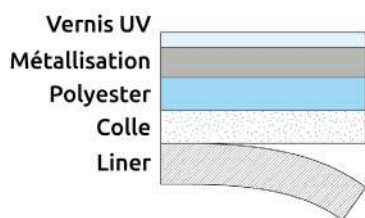

Bi-Couches

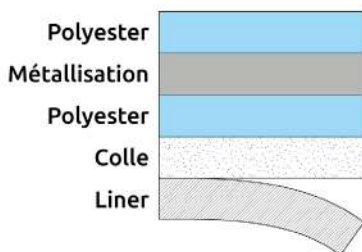

Multi-Couches

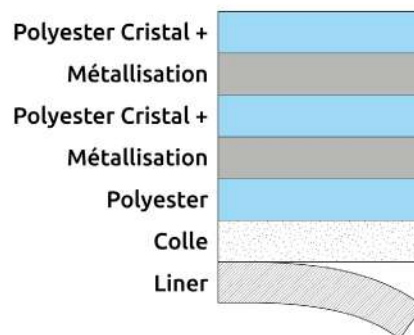

Schémas fournis à titre illustratif.

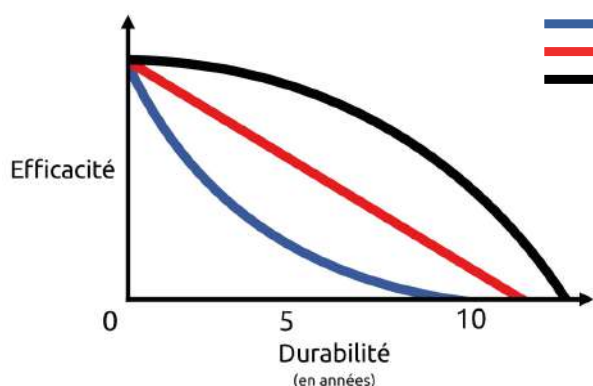

— GP
— Classique
— Zen

La Gamme **Zen Prestige** possède un traitement UV plus renforcé.

Selon la Gamme de qualité choisie, l'efficacité du produit diminuera de façon plus ou moins prononcée en fonction du temps.

CONSEILS DE POSE

Simple vitrage en pose intérieure

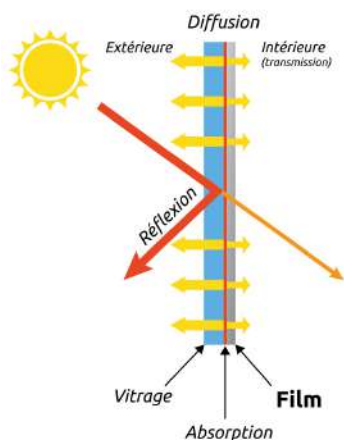

Effacité, Longévité

Double vitrage en pose intérieure

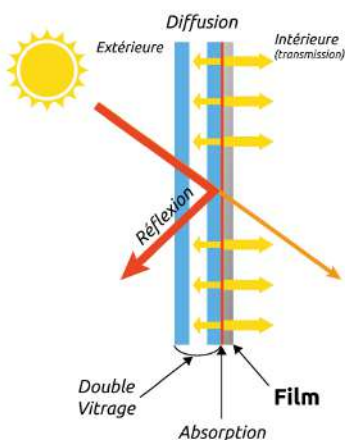

Baisse de Performance,
↑ Risque de choc Thermique



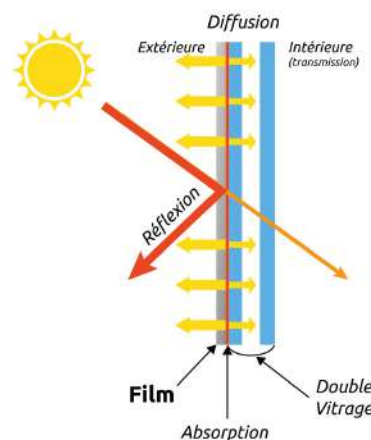







Double vitrage en pose extérieure



Effacité, Longévité avec Film de Qualité

Schémas fournis à titre illustratif.

Tableau Comparatif de nos Films Solaires

Référence	Gamme	Anti Chaleur	Anti Éblouissement	Clarté	Anti Froid	 Simple Clair	 Simple Feuilleté	 Double Clair	 Nouvelle Gen.	Efficacité Durabilité	Garantie
I-SOL 80		★★★★★	★★★★	★	★★★★★	INT	?	?	NON	★★★★	7 ans
I-SOL 50		★★★★		★★★★	★★★★	INT	INT	INT	?	★★★★	7 ans
MULTI 080		★★★★★	★★★★★	★		INT/EXT	INT ? /EXT	INT ? /EXT	INT ? /EXT	★★★★★	Int 12 ans Ext 10 ans
MULTI 070		★★★★★	★★	★★★★		INT/EXT	INT/EXT	INT/EXT	NON	★★★★★	Int 12 ans Ext 10 ans
MULTI 050		★★★★		★★★★		INT/EXT	INT/EXT	INT/EXT	INT ? /EXT	★★★★★	Int 12 ans Ext 10 ans
SOL 080		★★★★★	★★★★	★		INT	INT ?	INT ?	NON	★★★★	10 ans
SOL 080X		★★★★★	★★★★	★		EXT	EXT	EXT	EXT	★★★★	7 ans
SOL 065		★★★★	★★	★★★★		INT	INT	INT	INT ?	★★★★	10 ans
SOL 065X		★★★★	★★	★★★★		EXT	EXT	EXT	EXT	★★★★	7 ans
SOL 050		★★★★		★★★★		INT	INT	INT	INT ?	★★★★	10 ans
SOL 050X		★★★★		★★★★		EXT	EXT	EXT	EXT	★★★★	7 ans
SUN 80		★★★★★	★★★★	★		INT	INT ?	INT ?	NON	★★★★	10 ans
SUN 80X		★★★★★	★★★★	★		EXT	EXT	EXT	EXT	★★★★	5 ans
SUN 65		★★★★	★★	★★★★		INT	INT ?	INT ?	INT ?	★★★★	10 ans
SUN 65X		★★★★	★★	★★★★		EXT	EXT	EXT	EXT	★★★★	5 ans
SIL 80		★★★★★	★★★★★	★		INT	INT ?	INT ?	NON	★★	10 ans
SIL 80X		★★★★★	★★★★	★		EXT	EXT	EXT	EXT	★★	3 ans
SIL 70		★★★★★	★★★★	★		INT	INT ?	INT ?	INT ?	★★	10 ans
SIL 70X		★★★★★	★★★★	★		EXT	EXT	EXT	EXT	★★	3 ans
SOL 180		★★★★	★★★★	★★		INT	NON	NON	NON	★★★★	10 ans
SOL 180X		★★★★	★★★★	★★		EXT	EXT	EXT	EXT ?	★★★★	3 ans
SOL 165		★★	★	★★★★		INT	INT ?	NON	NON	★★★★	10 ans
SOL 165X		★★	★	★★★★		EXT	EXT	EXT	EXT ?	★★★★	3 ans
SOL 280		★★★★	★★★★★	★		INT	INT ?	NON	NON	★★★★	10 ans
SOL 280X		★★★★	★★★★★	★		EXT	EXT	EXT	EXT ?	★★★★	3 ans
SOL 380		★★★★	★★★★	★		INT	INT ?	NON	NON	★★★★	10 ans
SOL 380X		★★★★	★★★★	★		EXT	EXT	EXT	EXT ?	★★★★	3 ans
SOL 480		★★★★	★★★★	★		INT	INT ?	NON	NON	★★★★	10 ans
SOL 480X		★★★★	★★★★	★		EXT	EXT	EXT	EXT ?	★★★★	3 ans
SOL CH70		★★★★	★	★★★★★		INT	INT ?	INT ?	NON	★★★★	2 ans
SOL 405		★★★★		★★★★★		INT	INT	INT	INT ?	★★★★	10 ans
SOL 455X		★★★★		★★★★★		EXT	EXT	EXT	EXT	★★★★	7 ans
CERAMIQUE 70		★★★★		★★★★		INT	INT	INT	INT	★★★★★	10 ans

Ce tableau à but illustratif permet d'orienter son choix, il ne dispense pas de consulter la fiche technique.

Les films anti-UV filtrent les UV à différents niveaux selon la qualité choisie. Ils retardent la décoloration efficacement.



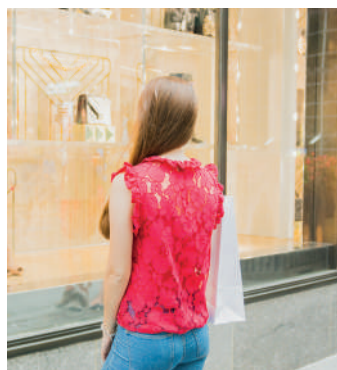



Astuce  Ne pas exposer d'objets rouges ou jaunes, ils sont très fragiles aux UV.



FULL UV



Anti UV légèrement grisé

 152 cm
 1 à 30 ml
 Filtre un spectre + large des UV
 Filtre UV à 100%
 **NON FEU**
 Pose sur verre et verre synthétique*
     











Film de protection qui filtre les rayons UV, jusqu'à 420nm de la lumière émise par le soleil ou la lune. Il représente donc la meilleure protection pour vitrines, musées...
Il filtre plus et plus longtemps.



UVA 10



Anti UV incolore

 152-183 cm
 1 à 30 ml
 Film qui ralentit la décoloration
 Filtre UV à 99.5%
 **NON FEU**
 Pose sur verre et verre synthétique*
     











Film de protection anti UV. Filtre les UV agressifs, en polyester nouvelle génération donc facile à poser.
Il est très efficace pour protéger tous les intérieurs...



UVA NET



Anti UV incolore

 152 cm
 1 à 30 ml
 Equilibre Qualité/Prix
 Filtre UV à 99%
 **NON FEU**
 Pose sur verre et verre synthétique*
     







Film de protection anti UV. Filtre les UV agressifs. Il est idéal pour protéger efficacement les vitrines, intérieurs de vos habitations...



UVG



Anti UV incolore

 152 cm
 5 à 30 ml par tranche de 5m
 1^{er} prix
 Ralentit la décoloration
 **NON FEU**
 Pose sur verre et verre synthétique*
     

Film anti UV 1^{er} prix. Filtre les UV agressifs. Protège l'intérieur de vos habitations, les vitrines...







Les films sécurités maintiennent efficacement le verre en place évitant de partir en éclat en cas de chocs. Ainsi ils transforment un simple vitrage en verre sécurisé répondant à la norme EN 12600 Sécurité de la personne et retardateur d'effraction. Ils protègent également des éclats de verre les zones de préparation alimentaire.



SEC 100



Film sécurité

 122-152 -183 cm	 1 à 30 ml	+ Film Sécurité 125µ + Ultra transparent
Pose sur verre		POLYESTER MULTI 25µ NON FEU
 		EN 12600 - 2B2

SEC 100X



Film sécurité

 152 cm	 1 à 30 ml	+ Film Sécurité 125µ + Ultra transparent
Pose sur verre		POLYESTER MULTI 25µ NON FEU
 		EN 12600 - 2B2



Film en polyester de nouvelle génération incolore, plus souple et résistant. Il est plus facile à poser, idéal pour les zones de préparations alimentaires.



E-SEC



Film sécurité incolore

 122-152 cm	 1 à 30 ml	+ Film polyester + 100µ incolore
Pose sur verre		POLYESTER 100µ NON FEU
 		EN 12600 - 3B3

E-SEC X



Film sécurité incolore

 152 cm	 1 à 30 ml	+ Film polyester + 100µ incolore
Pose sur verre		POLYESTER 100µ NON FEU
 		EN 12600 - 3B3





Film sécurité incolore, il maintient efficacement le verre en place évitant de partir en éclat en cas de choc.



GP-S100







Film sécurité incolore

 152 cm	 5 à 30 ml par tranche de 5m	+ Film polyester + 100µ incolore
Pose sur verre		POLYESTER 100µ NON FEU
 		EN 12600 - 3B3

GP-S100X



Film sécurité incolore

 152 cm	 5 à 30 ml par tranche de 5m	+ Film polyester + 100µ incolore
Pose sur verre		POLYESTER 100µ NON FEU
 		EN 12600 - 3B3

Film sécurité incolore, il maintient efficacement le verre en place évitant de partir en éclat en cas de choc.

*Toujours se référer au DTU 39



Le film **SEC 200** est doté d'une souplesse et d'une résistance, lui permettant de répondre aux exigences des préventions du risque industriel autour des sites SEVESO.

Les vitrages équipés des films SEC 200 sont testés suivant la norme EN 13541. Grâce à sa résistance à l'élongation de 170% avant rupture, le SEC 200 est la solution pour une protection efficace contre les éclats de verre en cas d'explosion en milieu industriel pour les locaux situés en zones à risques.



SEC 200



Film sécurité 195µ



+ Allongement 170%



Pose sur verre

EN 13541
EN 12600 - 1B1



ATTENTION : Les films sécurités sont épais donc ils ne doivent pas être manipulés avant la pose, ils doivent toujours être stockés dans leur emballage d'origine adhésivé (des tunnels pourraient se former sans cela).



Le film **SEC 220** est un retardateur d'effraction, il maintient efficacement le verre en place évitant de partir en éclat en cas de chocs.

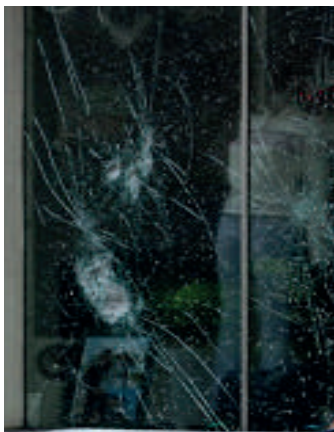

SEC 220



Film sécurité 215µ



+ Retardateur d'effraction



Pose sur verre

EN 12600 - 1B1

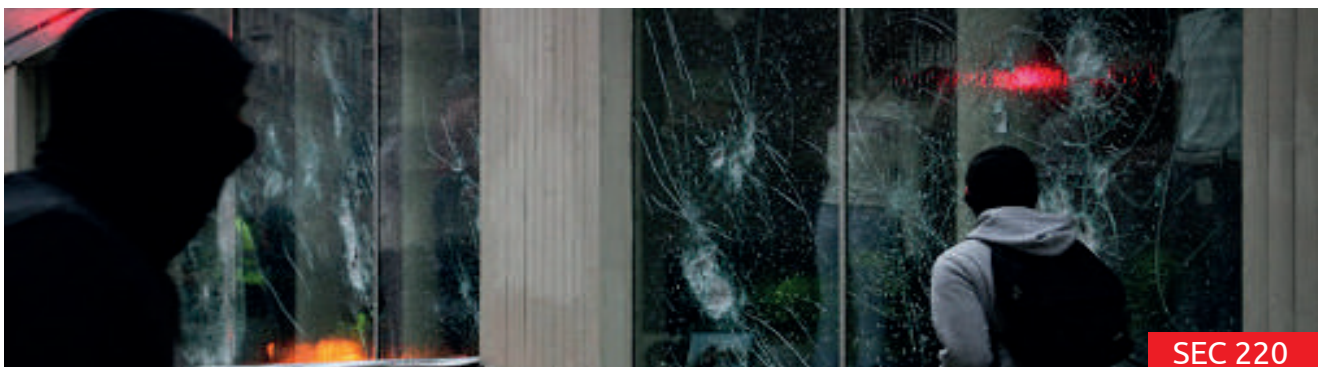

SEC 220



SEC MET 100

Film solaire 3 en 1

- 152 cm
- 1 à 30 ml
- Film sécurité 100µ
- Anti chaleur et Miroir sans tain
-
-
- Pose sur verre
- EN 12600 - 2B2
-
-
-
-
-

Il protège de la chaleur, réduit l'éblouissement, il est miroir sans tain et film de sécurité de la personne.

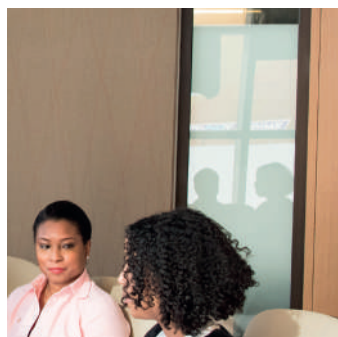

SEC DEP 100

Film sécurité dépoli

- 152 cm
- 1 à 30 ml
- Film sécurité 150µ
- Dépoli blanc
-
-
- Pose sur verre
- EN 12600 - 2B2
-
-
-
-
-

Il maintient efficacement le verre en place évitant de partir en éclat en cas de choc et protège des regards indiscrets.

ANTI GRAFFITIS

Ils protègent le verre de toute agression (peinture, acide fluorhydrique, gravure). Sans transfert de colle, ils se changent rapidement.



AG-CR 400

Film anti graffitis

- 152 cm
- 1 à 30 ml
- Change rapide sans résidus de colle
-
-
- Pose sur verre et sur toute surface lisse et bloquée
-
-

A-GRAF

Film anti graffitis

- 152 cm
- 1 à 30 ml
- Polyester 100µ
- Longue durée
-
-
- Pose sur verre et sur toute surface lisse et bloquée
-
-



GP-GRAF

Film anti graffitis

- 152 cm
- 5 à 30 ml par tranche de 5m
- Change rapide sans résidus de colle
-
-
- Pose sur verre et sur toute surface lisse et bloquée
-

GP-GRAF X

Film anti graffitis

- 152 cm
- 5 à 30 ml par tranche de 5m
- Polyester 100µ
- Longue durée
-
-
- Pose sur verre et sur toute surface lisse et bloquée
-

*Toujours se référer au DTU 39



SECURVIT

la gamme pro
Classique



A appliquer des **deux** côtés du vitrage

POLYESTER 100μ



- + Protège des blessures
- + Rapide à installer
- + N'occulte pas la luminosité

Ce film se pose directement avec son liner d'application.

Maintient en place le verre qui est cassé le temps de remplacer le vitrage afin d'éviter les sur-accidents.

FILM DOS DE MIROIR

Les films protection de dos de miroir sont des films de sécurisation des miroirs. Ils s'appliquent au dos des miroirs afin de sécuriser les personnes en cas d'impact. Ils respectent les exigences de la norme BS.

DOS SEC 100

Zen
la gamme

Film sécurité dos des miroirs



- + Film sécurité 100μ
- + Pose à sec possible

POLYESTER MULTI 100μ NON FEU

Pose sur dos de miroir



DSEC+

la gamme pro
Classique

Film sécurité dos des miroirs



- + Polyester 90μ
- + Pose aqueuse

POLYESTER 90μ NON FEU

Pose sur dos de miroir



GP DSEC

GP
Films pour vitrage

Film sécurité dos des miroirs



- + Polyester 95μ
- + Pose aqueuse

POLYESTER 95μ NON FEU

Pose sur dos de miroir





Les produits MASK Films de sablage et peinture pour réaliser des pochoirs.



MASK 230

120 cm 1 à 25ml

230 μ , souple et tenue dimensionnelle

- + Épaisseur et souplesse
- + Film de sablage haute résistance pour les vitrages
- + Parfait pour les pochoirs peinture

MASK 100

120 cm 5 à 25 ml par tranche de 5m

100 μ d'épaisseur, colle forte

- + Économique
- + Sablage léger pour vitrages
- + Possible pour les pochoirs peinture

Leurs épaisseurs et leurs souplesses les rendent très faciles à poser et à utiliser, principalement pour protéger vos vitrages lors de sablage ou peinture.

Ces films peuvent passer en plotter de découpe.
La personnalisation sur mesure est disponible sur ces produits.



Nous pouvons vous les livrer personnalisés !





Films pour verre laqué, posés au dos d'un vitrage ils vous permettent de créer un rendu verre laqué, parfait pour les crédences de cuisine !

OPAC 600



Film opaque de couleur



122 cm



1 à 25 ml

- + Longévité
- + Intérieur & Ext.

POLYMERE 75µ

NON FEU

Pose sur verre et verre synthétique*



10 ANS GARANTIE



5 ANS GARANTIE



Film vinyle, teinté dans la masse, longue durée, qui permet d'imiter du verre laqué quand posé au dos d'un vitrage

Se pose sur tout type de verre (feuillure) pour vos crédences. Voir nuancier opaques page 9.

Nous pouvons vous les livrer personnalisés !



Ces produits MASK Bandes et films de masquage et de protection destinés à la protection temporaire de vos vitrages, sans laisser de traces, pour les protéger lors de travaux sur place ou dans lors du transport.



MASK 05

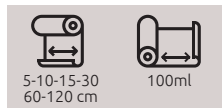

- + Film Adhésif
- + Très souple
- + Transparent



PAPER MASK

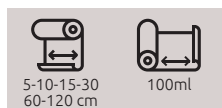

- + Papier Adhésif
- + Économique

Parfaits pour protéger vos vitrages aussi bien lors de travaux ou de transport - des petits chocs, de peinture ou encore de la poussière.





Protégent vos portes contre les agressions du quotidien avec efficacité et esthétique.

Les avantages :

- Rapide à poser
- Facile à changer
- Bon rapport qualité/prix
- Esthétisme

⊕ Astuce

Nous pouvons également réaliser des modèles sur mesure dans la teinte et la forme de votre choix, sur devis.

SOUBASSEMENT DE PORTE



S-PROTECT SOU

POSE SUR TOUTE SURFACE LISSE ET BLOQUÉE, UN TEST D'ACCROCHE EST CONSEILLÉ*

- ⊕ Lessivable
- ⊕ Bonne résistance à l'abrasion
- ⊕ Pose rapide
- ⊕ Esthétique
- ⊕ Facile à changer
- ⊕ Bon rapport qualité/prix

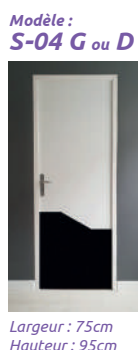

PROTECTION DE POIGNÉE



S-PROTECT PGN

POSE SUR TOUTE SURFACE LISSE ET BLOQUÉE, UN TEST D'ACCROCHE EST CONSEILLÉ*

- ⊕ Lessivable
- ⊕ Bonne résistance à l'abrasion
- ⊕ Pose rapide
- ⊕ Esthétique
- ⊕ Facile à changer
- ⊕ Bon rapport qualité/prix

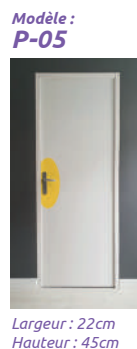



S-PROTECT VER

Pose sur toute surface lisse et bloquée, un test d'accroche est conseillé*

- + Lessivable
- + Pose rapide
- + Facile à changer
- + Bonne résistance à l'abrasion
- + Esthétique
- + Bon rapport qualité/prix



⊕ Astuce

Utiliser une teinte contrastée avec le support répondra à une exigence pour l'accueil des personnes malvoyantes.

S-Protect permet de protéger une partie de votre porte. Cette gamme vous aide à diminuer les risques de dégradations dus aux contacts, frottements et aux chocs répétés. Disponibles en 26 coloris mats grainés :

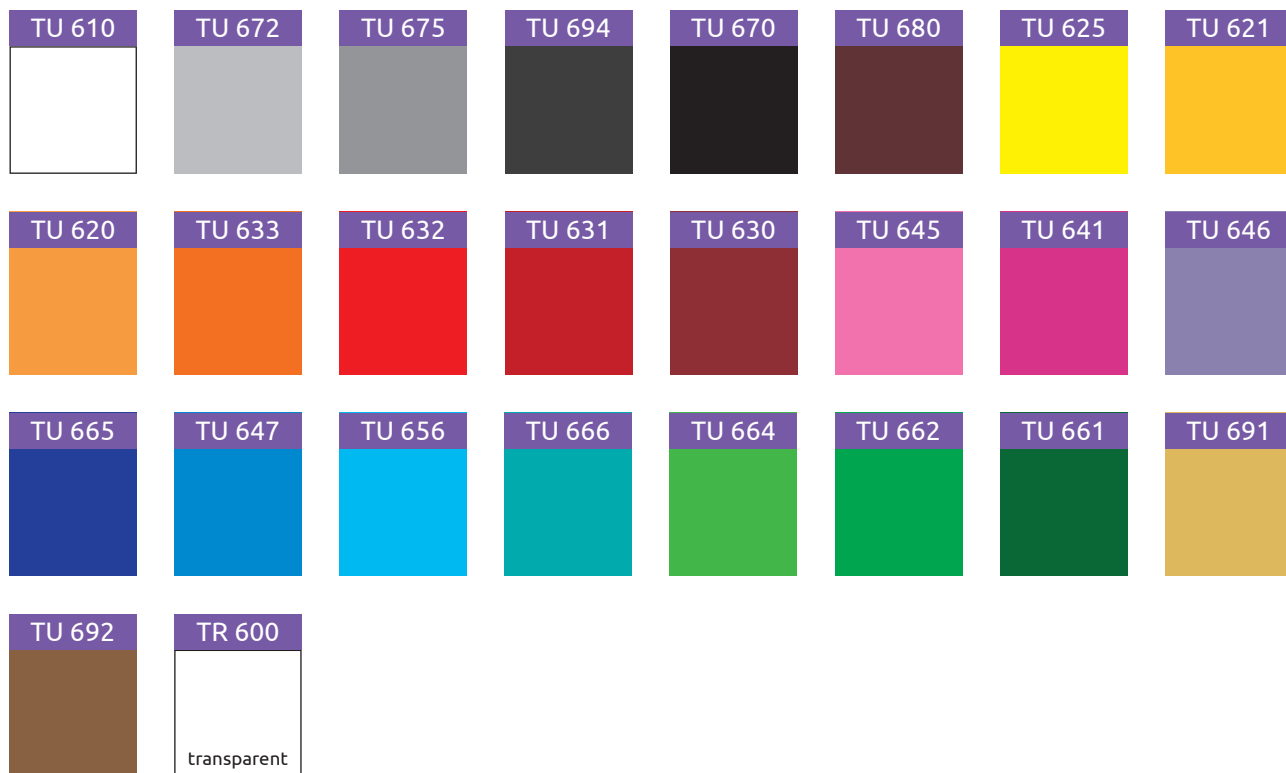

*Il est conseillé de faire un test d'accroche. Toujours se référer au DTU 39.



Installation recommandée :

Il est conseillé de mettre une 3^{ème} bande à hauteur de 50 cm lorsqu'il y a présence de jeunes enfants (les crèches, les écoles...).

Couleurs contrastées :

Le fond d'un vitrage est souvent d'apparence sombre vu de l'extérieur. Il est donc conseillée de mettre des bandes de couleurs vives comme le blanc, le jaune, le rouge le bleu vif...



Pose sur verre et verre synthétique*



VISION ROND

8 cm 1 lot de 36 ronds individuels



+ Livré en 6 planches pour plus de praticité

Motif à préciser

Rond Dep

Rond Blanc

Rond Rouge

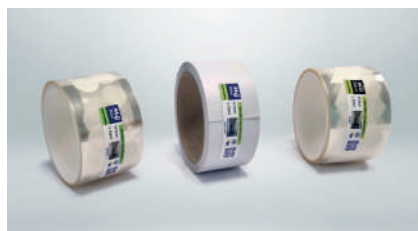
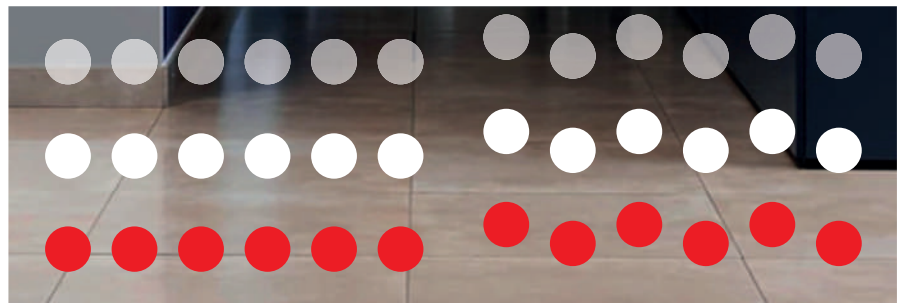

VISION BANDE



5 cm

10 cm



+ Large choix de modèles

Motif à préciser

Opac Rouge

Opac Bleu

Opac Jaune

Opac Blanc

Dep



*Il est conseillé de faire un test d'accroche. Toujours se référer au DTU 39.

Nous pouvons créer vos bandes de visualisation, contactez-nous !

Motif à préciser

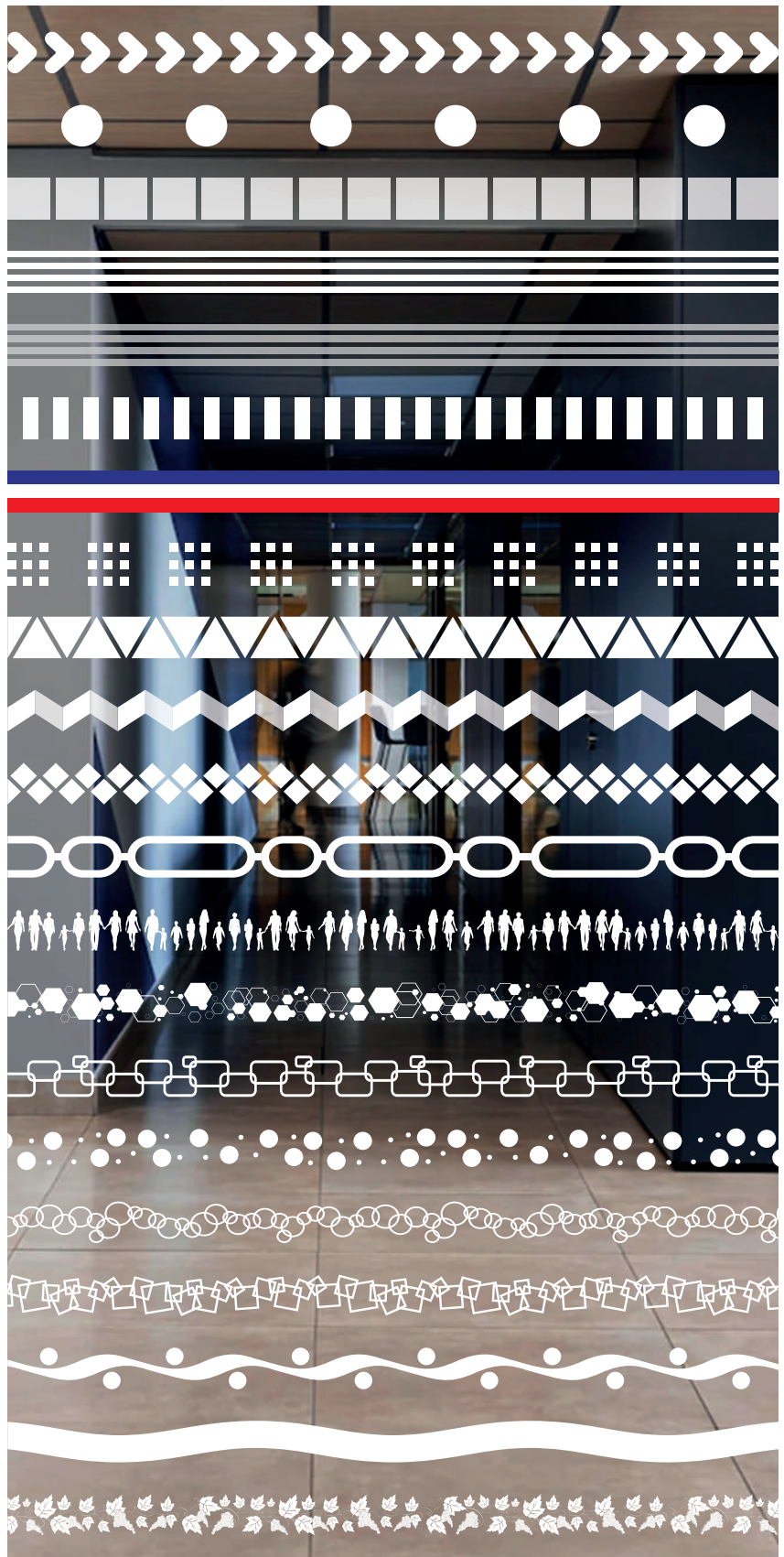
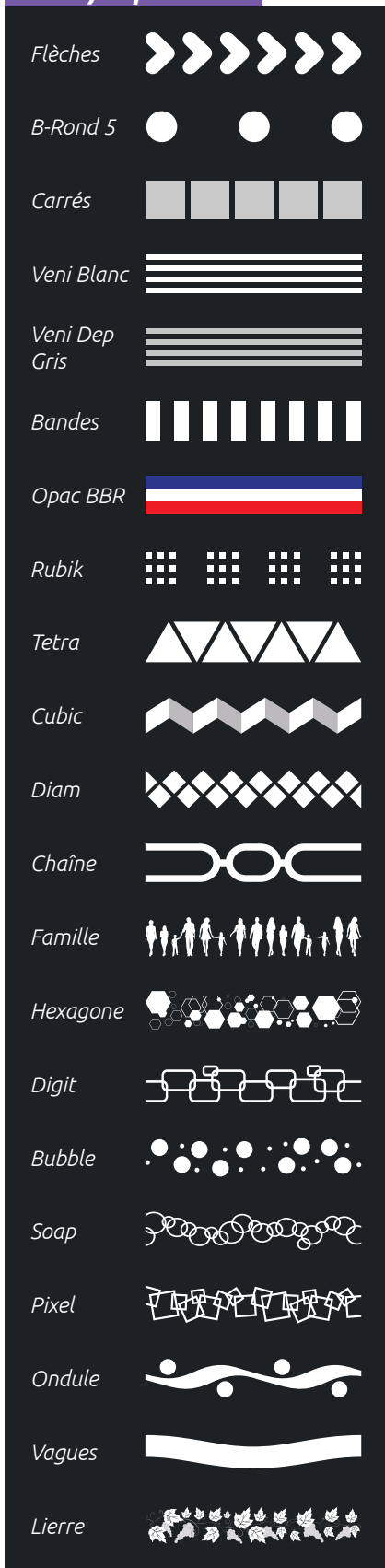

**Il est conseillé de faire un test d'accroche. Toujours se référer au DTU 39.*



BANDES ANTI DÉRAPANTES ADHÉSIVES AVEC GRIP RENFORCÉ

Pose sur surface lisse et bloquée*



B-SUP ADR N 19



B-SUP ADR N 25



B-SUP ADR N 36

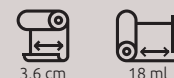

B-SUP ADR N 50



B-SUP ADR N 100



- + Anti dérapant adhésif à grip renforcé
- + Abrasif sur support PVC.

Pose sur surface lisse et bloquée*



B-SUP ADR 19



B-SUP ADR 25



B-SUP ADR 36



B-SUP ADR 50



B-SUP ADR 100



- + Anti dérapant adhésif à grip renforcé
- + Abrasif sur support PVC.

Pose sur surface lisse et bloquée*



B-SUP ADR Z 19



B-SUP ADR Z 25



B-SUP ADR Z 36

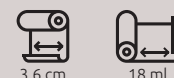

B-SUP ADR Z 50



B-SUP ADR Z 100



- + Anti dérapant adhésif à grip renforcé
- + Abrasif sur support PVC.
- + Jaune/Noire ou Rouge/Blanc

Ces bandes résistantes offrent un grip puissant. Elles conviennent aux usines, et autres endroits à fort passage.

Résistantes à l'eau, huiles moteurs et produits chimiques (PSTC-35).

Coefficient de friction : 102TRL sec, et 71 TRL humide.

Essais conforme à ASTM C 1028-96.

Pour un usage pédestre.

*Il est conseillé de faire un test d'accroche.

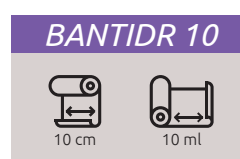
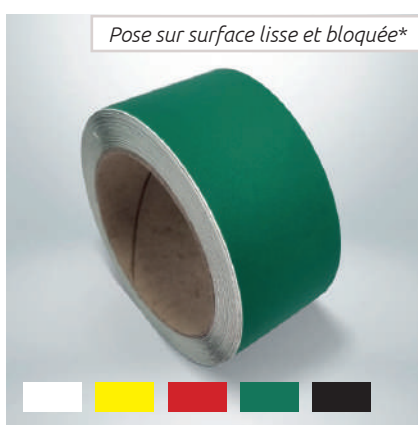

- + Anti dérapant adhésif à grip doux
- + Abrasif sur support PVC.

Cette bande adhésive anti dérapante possède un toucher doux et non abrasif. Elle est idéale pour lieux habités ou d'accueil où l'esthétique est un critère important.

Il est possible de les avoir personnalisées pour plus d'esthétisme.

BANDES ANTI DÉRAPANTES AQUA



Les bandes adhésives antidérapantes aqua sont idéales pour les milieux humides, pour les nez de marches, zones résidentielles etc... Leur grain, bien que très rugueux n'est pas abrasif et ne blesse pas.

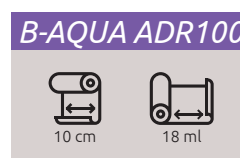
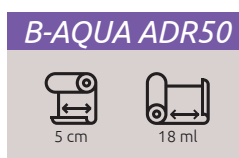
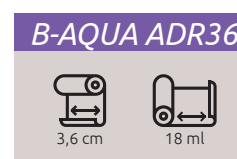
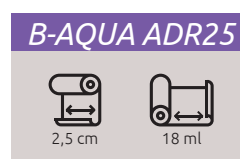
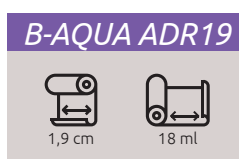
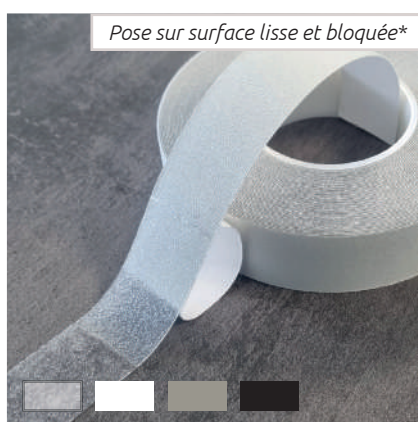

- + Bandes antidérapantes épaisses pour milieu humide
- + Conforme à ASTM C 1028-96
- + Usage pédestre

*Il est conseillé de faire un test d'accroche.



SIGNAL 5



SIGNAL 10



Pose sur surface lisse et bloquée*

- + Jaune/Noire ou Rouge/Blanc

Bandes adhésives SIGNAL sont hachurées par impression et lamination anti rayure et anti UV.



BALIZE 5



BALIZE 10



Pose sur surface lisse et bloquée*

- + Adhésif vinyle polymère, bande hachurée
- + Teintée dans la masse pour marquage sol et mur

Bandes hachurées par co-lamination de films teintés dans la masse avec traitement anti UV.

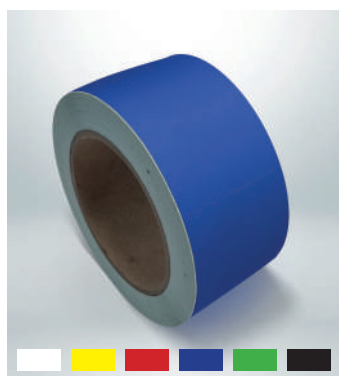

LINEAL 5



LINEAL 10



Pose sur surface lisse et bloquée*

- + Bande sol et contre marche avec liner d'application

Bande de signalisation pour marquage au sol uni, avec liner d'application et colle acrylique, facile à poser.

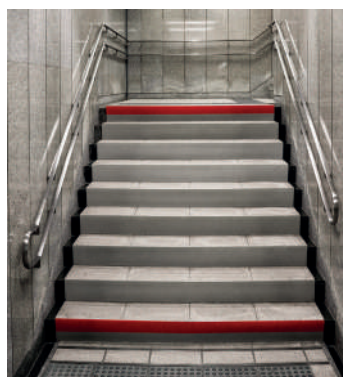

C-MARCH 10



Pose sur surface lisse et bloquée*

- + Bandes de couleurs contrastées mat

Bandes Contremarche colaminées PVC pour la visualisation des escaliers.

*Il est conseillé de faire un test d'accroche.



BDS TEX



Pose sur surface lisse et bloquée*

- + Pose sur surface lisse et bloquée
- + Lot de 6 bandes

Bande adhésive avec **texte imprimé personnalisable** en PVC 80μ. Pour signaler et avertir, disponible en 3 couleurs : Jaune, Rouge et Bleu.

ZONE DE CONFIDENTIALITÉ

MERCI DE NE PAS FRANCHIR CETTE LIMITE

MERCI DE RESPECTER UNE DISTANCE DE 1M



B PHLUM



Pose sur surface lisse et bloquée*

- + Forte adhérence

Bande adhésive en PVC photoluminescente. La journée de teinte écrue, elle accumule l'énergie, et la nuit tombant il restitue la lumière pendant plus de 5 heures. (En fonction du temps d'éclairage dans la journée) Pour signaler et avertir la nuit.



B PHLUM-ZE



Pose sur surface lisse et bloquée*

- + Forte adhérence
- + Zébra vert et jaune pâle

Bande adhésive en PVC photoluminescente zébrée. La journée de teinte écrue et verte, elle accumule l'énergie, et la nuit tombant il restitue la lumière pendant plus de 5 heures. (En fonction du temps d'éclairage dans la journée) Pour signaler et avertir la nuit.



*Il est conseillé de faire un test d'accroche.





Pochoirs réutilisables en PVC expansé 3 mm semi rigide. Facile à utiliser et facile à nettoyer. Nous pouvons également réaliser un pochoir sur mesure avec le motif de votre choix sur devis.



POC PMR GR



dim. poc	dim. motif
 60 x 70 cm	 50 x 60 cm

POC PMR PT

dim. poc	dim. motif
 35 x 40 cm	 25 x 30 cm





POC INTERDIT DE STATIONNER

dim. poc	dim. motif
 90 x 90 cm	 80 x 80 cm

Pochoir en 2 parties :
1^{ère} partie le contour **A**
2^{ème} partie la diagonale **B**





POC LIMIT10

dim. poc	dim. motif
 90 x 90 cm	 80 x 80 cm



POC LIMIT 30

dim. poc	dim. motif
 90 x 90 cm	 80 x 80 cm



POC PIETON GR

dim. poc



70 x
100 cm

dim. motif



50 x
80 cm

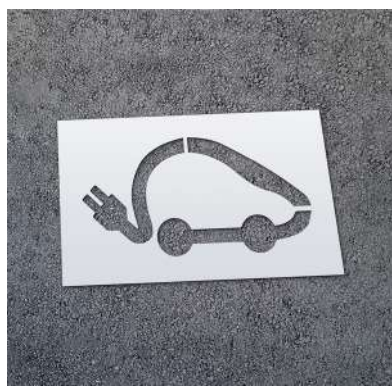

POC ELEC GR

dim. poc



120 x
70 cm

dim. motif



100 x
50 cm



POC MOTO

dim. poc



70 x
62 cm

dim. motif



50 x
42 cm



POC VELO

dim. poc



70 x
52 cm

dim. motif



50 x
32 cm



STICKER PVC



En rectangle :
1,5x10cm - 3x10cm
5x18cm - 10x21cm
21x30cm - 40x60cm



En carré :
5cm - 10cm
15cm - 25cm
50cm

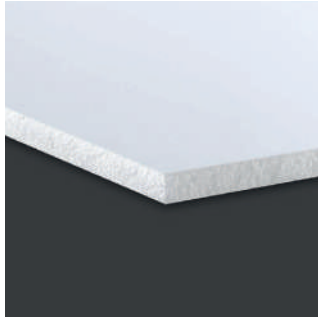

PVC EXPANSÉ 3MM



En rectangle :
1,5x10cm - 3x10cm
5x18cm - 10x21cm
21x30cm - 40x60cm



En carré :
5cm - 10cm
15cm - 25cm
50cm

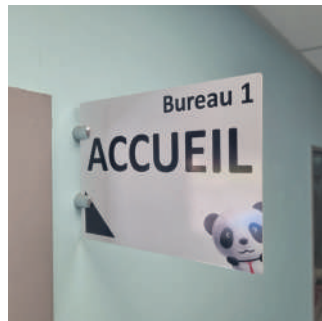
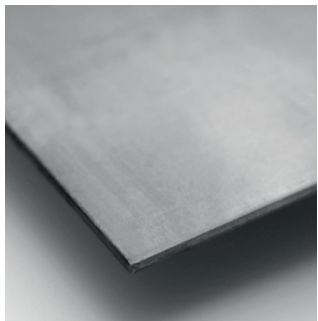

ALUMINIUM 1MM



En rectangle :
1,5x10cm - 3x10cm
5x18cm - 10x21cm
21x30cm



En carré :
5cm - 10cm
15cm - 25cm



DI-ALU 3MM



En rectangle :
1,5x10cm - 3x10cm
5x18cm - 10x21cm
21x30cm - 40x60cm



En carré :
5cm - 10cm
15cm - 25cm
50cm

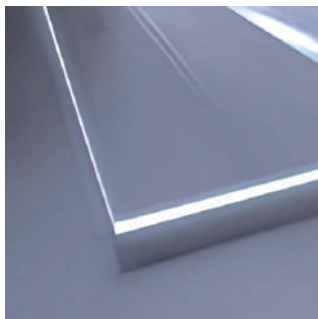

PMMA 3MM



En rectangle :
1,5x10cm
3x10cm
5x18cm



En carré :
5cm - 10cm
15cm

PMMA 5MM



En rectangle :
10x21cm
21x30cm
40x60cm



En carré :
25cm - 50cm

Nos plaques sont personnalisables, avec du texte, couleur de fond ou photo de fond !

Options disponibles :

■ BRAILLE VERNIS EMBOSSÉ



■ RELIEF VERNIS EMBOSSÉ



■ PLAQUE RELIEF



■ ASPECT BROSSÉ
Filmé Cuivre, Alu ou Noir



Quelques exemples d'application :



1 Panneau de porte (Drapeau)

2 Panneau suspendu

3 Plaque sur entretoises

4 Lettrage découpé (PVC ou Alu composite)

5 Sticker ou panneau Mural (PVC ou Alu composite)

6 Plaque de comptoir (PMMA)

7 Plaque de protection COVID (PMMA)

8 Adhésif de sol

*Il est conseillé de faire un test d'accroche.



Ces films adhésifs sont utilisés pour réaliser des tableaux blancs ou transparents effaçables à sec. Ils s'appliquent sur toutes surfaces lisses et bloquées telles que les anciens tableaux, les murs, les portes et autres supports. Ils permettent d'écrire au marqueur effaçable et sont nettoyés avec un chiffon ou une brosse à tableau.



VEL B100

Film tableau blanc

		+ Effaçable à sec usage intensif
120-150 cm	1 à 30 ml	
		Pose sur toute surface lisse et bloquée



+ Astuce

Vous souhaitez un tableau avec une inscription, des lignes seys, un tableau précis... et qui ne s'effacera pas !!! Nous le réalisons sur mesure selon votre demande. Demandez un devis !

Ce film tableau blanc effaçable à sec, de haute qualité, permet d'écrire avec les feutres de marque BOSS PLAN et STAEDLER. Il présente l'avantage de s'effacer même après plusieurs mois d'écritures.



VEL T000

Film tableau transparent

		+ Effaçable à sec usage intensif
120 cm	1 à 30 ml	
		Pose sur toute surface lisse et bloquée

VEL T910

Film tableau vitrage

		+ Effaçable pour vitre
150 cm	1 à 30 ml	
		Pose sur verre et verre synthétique*

Ces films tableaux transparents effaçables à sec, de haute qualité, permettent d'écrire avec les feutres de marque BOSS PLAN et STAEDLER. Ils présentent l'avantage de s'effacer même après plusieurs mois d'écritures.

TABLEAU ARDOISE



TAB NERO/VERDE

Film tableau noir/vert

		+ Usage fréquent
120 cm	1 à 25 ml	
		Pose sur toute surface lisse et bloquée



Ce film tableau adhésif noir et vert permet d'écrire à la craie et de réaliser des décorations originales, des ardoises... Il s'efface à l'éponge humide. Ne pas utiliser de feutre craie.







Ce film magnétique et effaçable à sec vous permet d'obtenir rapidement et en une seule application un tableau magnétique pouvant recevoir des aimants, avec une surface blanche effaçable à sec. Il est préférable d'utiliser des feutres de marque **BOSS PLAN** et **STAEDLER**.



MAGNET BL



Film tableau blanc ferreux

 120 cm	 1 à 10 ml	+ Film tableau blanc sur métaux ferreux adhésif
		
		POLYESTER PVC 160µ
Pose sur toute surface lisse et bloquée		



Astuce feutre

Vous écrivez par erreur avec un feutre indélébile, utilisez le CLEAN POWER. Il s'effacera sans effort. Fonctionne également sur d'autres supports avec de nombreuses encres.

FILMS ÉCRAN



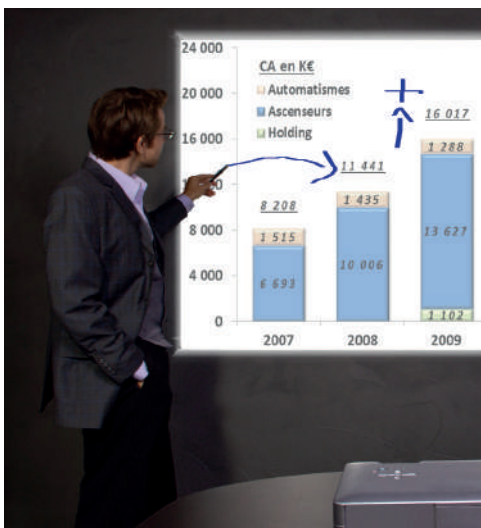

Ces films écrans de projection s'appliquent sur toutes surfaces lisses, propres et bloquées et permettent une vidéo-projection sans reflet.



TAB SCREEN



Effaçable et écran mat

 135 cm	 1 à 25 ml	+ Film adhésif tableau effaçable + Ecran de projection mat
		
		PVC 180µ blanc mat
Pose sur toute surface lisse et bloquée		

Il permet la vidéo projection sans avoir les reflets. S'efface avec un chiffon légèrement humide. Entretien : Nettoyer de temps en temps avec de l'alcool ménager.

*Toujours se référer au DTU 39



Stores vénitiens en aluminium
Fabrication sur mesure et expédition
sous 4 à 5 semaines



VÉNITIEN

- + Store à lamelles horizontales 25 mm
- Matière : aluminium laqué
- Guidage option : Perlon
- Largeur : sur mesure de 30 à 270 cm
- Hauteur : sur mesure de 50 à 190 cm
- Nombreux coloris disponibles

Les dimensions à fournir :

L : Longueur totale hors tout

H : Hauteur totale, mécanisme et barre de charge comprise

A : Allège, du bas du store jusqu'au sol

Retrouvez notre
nuancier complet
sur notre site !

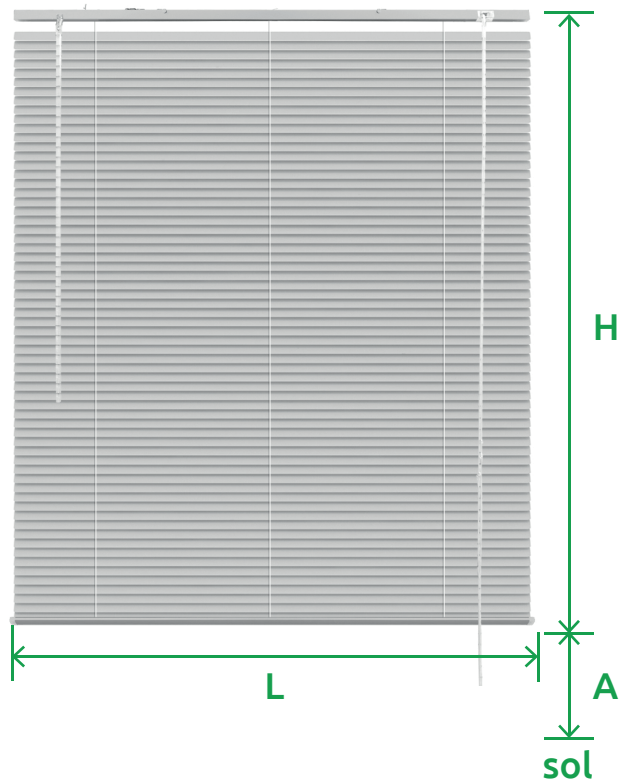
**Prise de mesures :**

Options : nous consulter

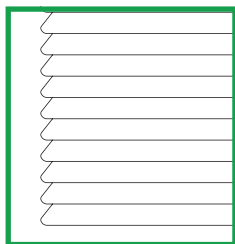

15 mm

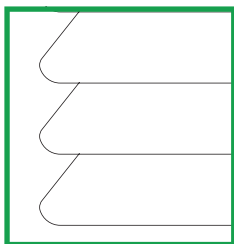

50 mm

Mécanisme

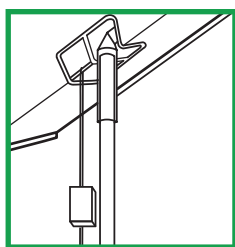

Cordon et tige

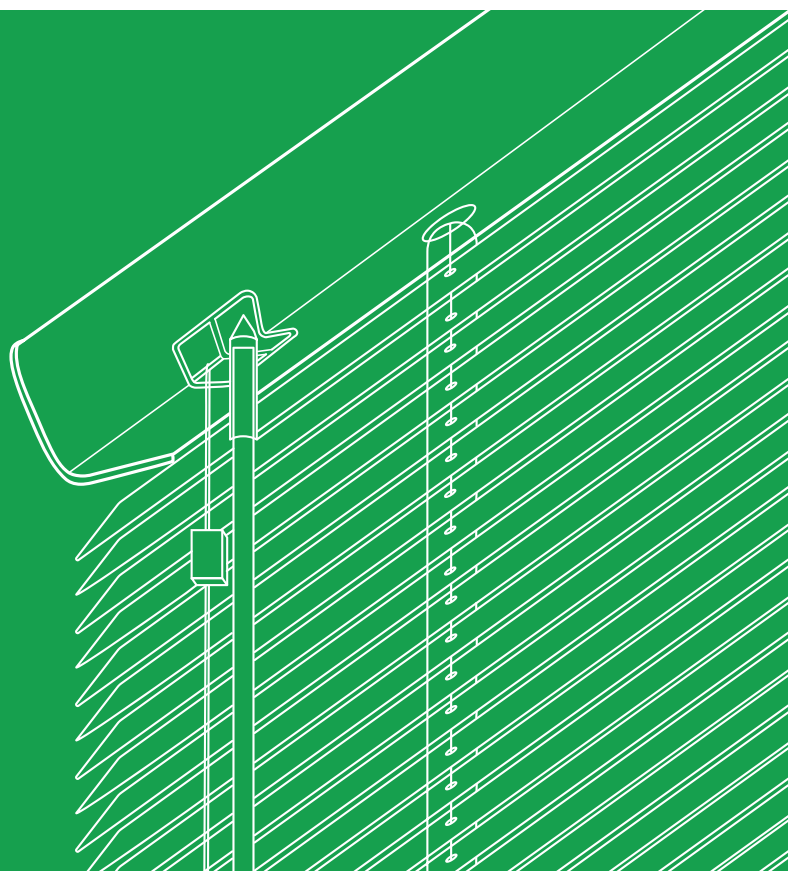
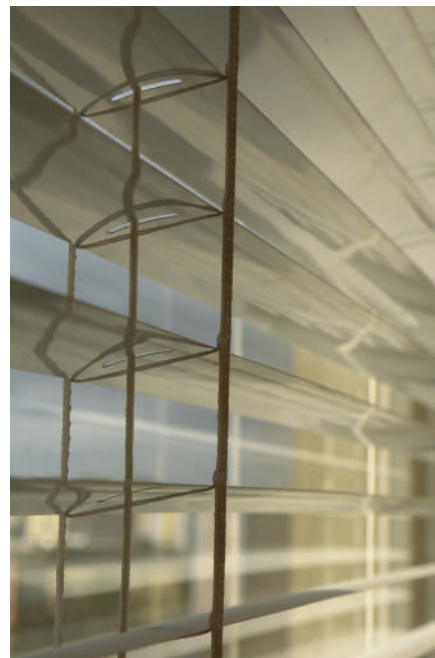

190cm
TAILLE
MAXIMALE
CLASSIQUE
270cm



Stores à enroulement
Fabrication sur mesure et expédition
sous 4 à 5 semaines



CLIPY

- + Store à enroulement : **pose facile par clip**
- Toiles/films compatibles : tous (gaufrés ou plissés)
- Largeur : sur mesure de 30 à 300 cm
- Hauteur : sur mesure de 50 à 300 cm
- Coffre : en option
- Option : Perlon, Rail U, Rail coffre



CLASSIC

- + Store à enroulement : **pose par étrier**
- Toiles/films compatibles : tous (gaufrés ou plissés)
- Largeur : sur mesure de 30 à 300 cm
- Hauteur : sur mesure de 50 à 300 cm
- Coffre : NON
- Option : Perlon, Rail U

Les dimensions à fournir :

L : Longueur totale hors tout

H : Hauteur totale, mécanisme et barre de charge comprise

A : Allège, du bas du store jusqu'au sol

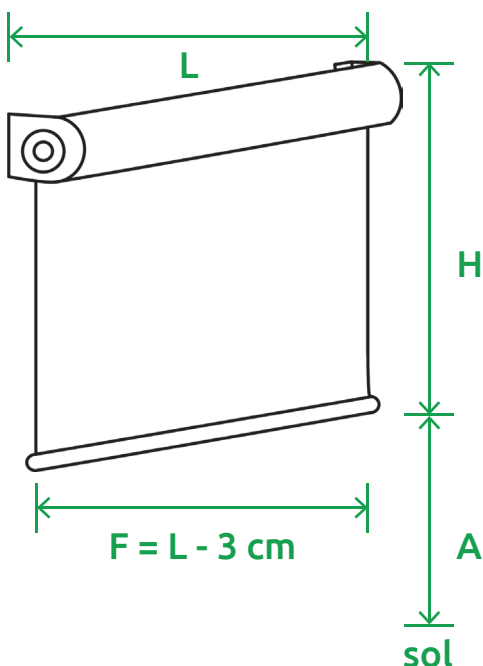
Prise de mesures :

Options : nous consulter

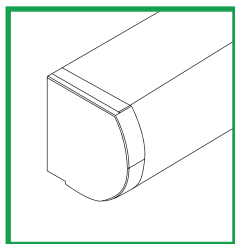

Coffre

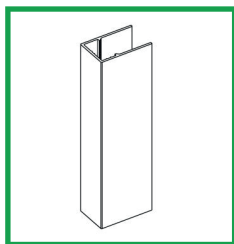

Rail U ou
Rail Coffre

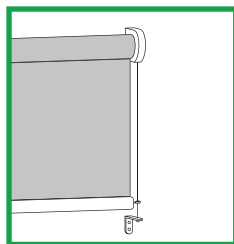

Guidage Perlon

Mécanismes

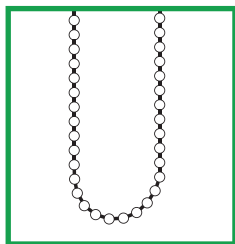

Chainette Nickel

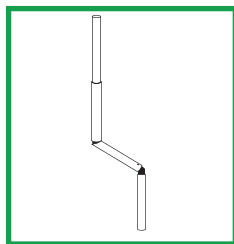

Treuil

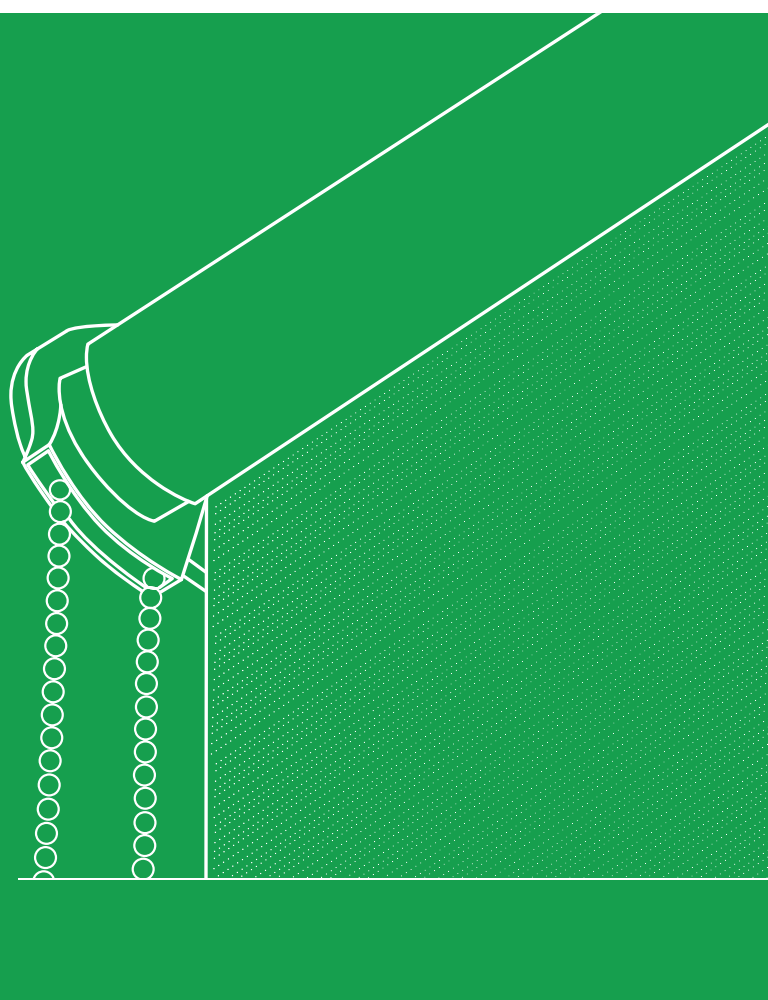

300cm
TAILLE
MAXIMALE
CLASSIQUE
300cm

450cm
TAILLE
MAXIMALE
HORS NORMES
450cm

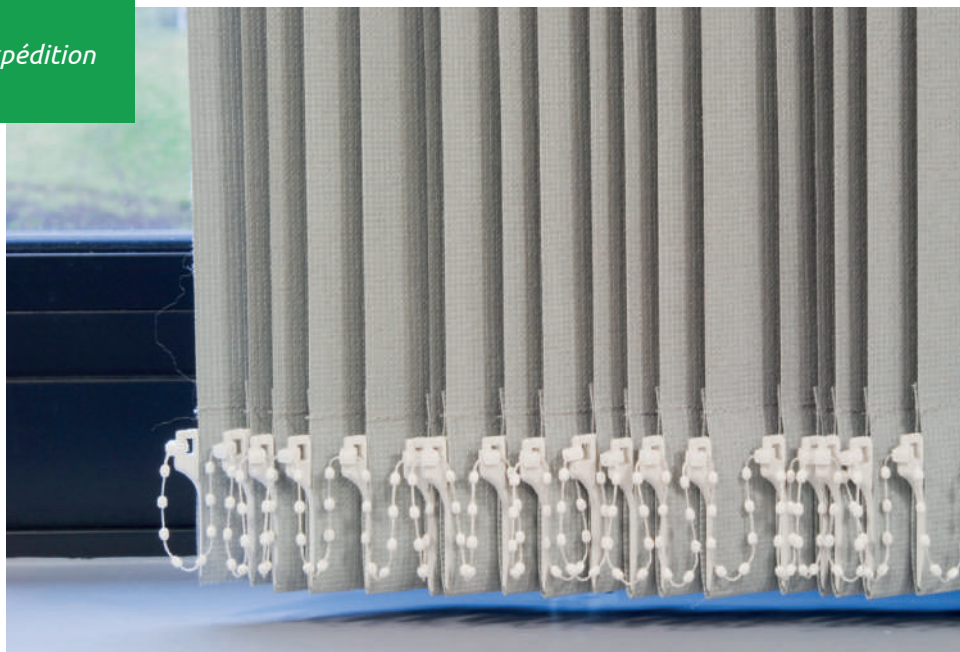
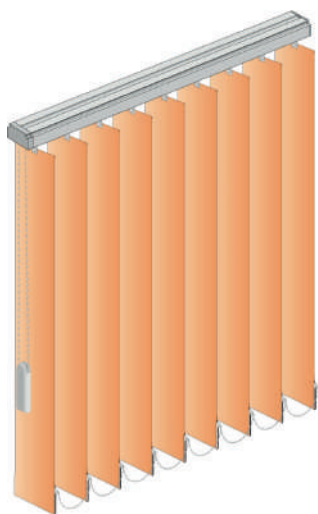
**Stores californien***Fabrication sur mesure et expédition sous 4 à 5 semaines***LAMELLE 89***Idéal pour le vitrage de faible et moyenne hauteur*

- + Store à lamelles 89 mm
- Toiles/films compatibles : tous (gaufrés)
- Largeur : sur mesure de 30 à 300 cm
- Hauteur : sur mesure de 50 à 370 cm
- Option : Mono commande :
Ouverture et orientation des lamelles en 1 geste
- Delai +2 semaines

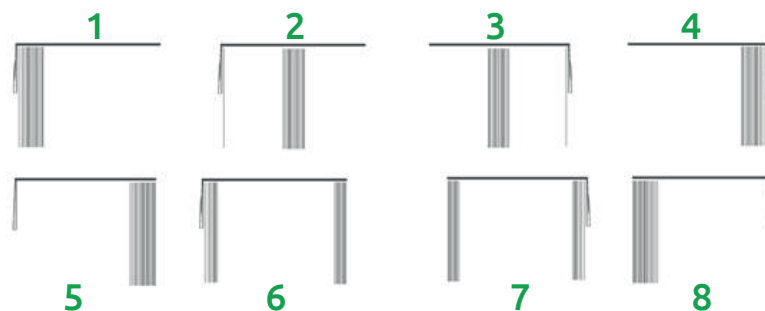
Choix d'ouverture :**LAMELLE 127***Idéal pour les baies latérales portes vitrées*

- + Store à lamelles 127 mm
- Toiles/films compatibles : tous (gaufrés)
- Largeur : sur mesure de 30 à 300 cm
- Hauteur : sur mesure de 50 à 370 cm
- Option : Mono commande :
Ouverture et orientation des lamelles en 1 geste
- Delai +2 semaines

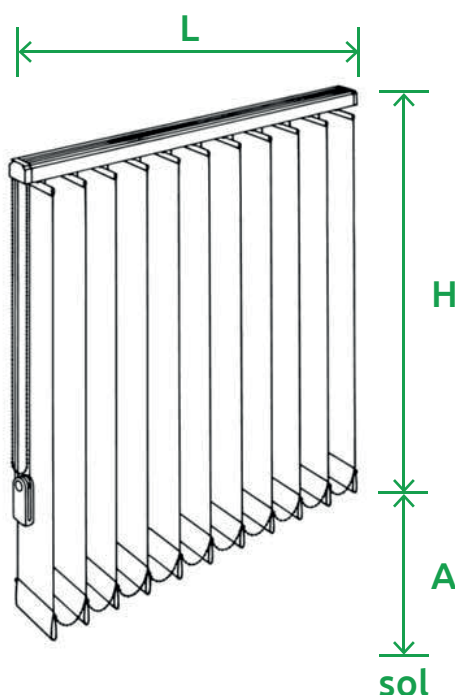
Prise de mesures :**Les dimensions à fournir :****L** : Longueur totale hors tout**H** : Hauteur totale, mécanisme et barre de charge comprise**A** : Allège, du bas du store jusqu'au sol

Options : nous consulter

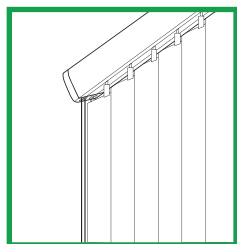

Verticales

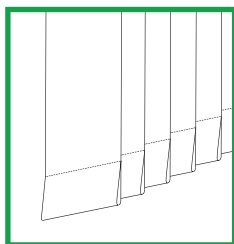

89, 127mm

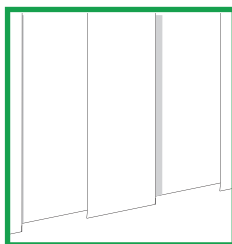

Paroi japonaise



Mécanismes

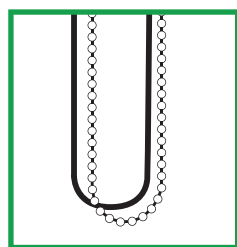

Cordon et
Chainette



Monocommande

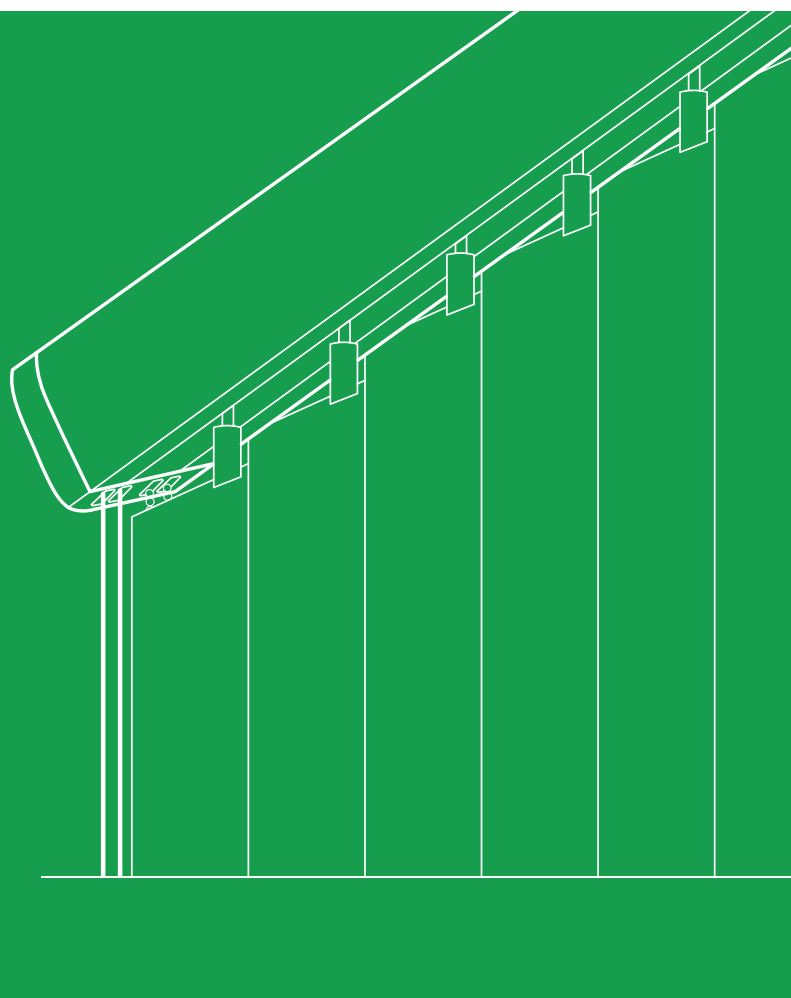

370cm
TAILLE
MAXIMALE
CLASSIQUE
300cm

500cm
TAILLE
MAXIMALE
HORS NORMS
450cm



Pour les stores à enroulement
et pour les bandes verticales

Nuancier des toiles classiques



Nuancier des toiles M1



Vous pouvez aussi choisir de personnaliser votre store avec un visuel que ce soit pour décorer ou communiquer !



Pour les stores à enroulement

Zen
la gamme



Nuancier des toiles M1

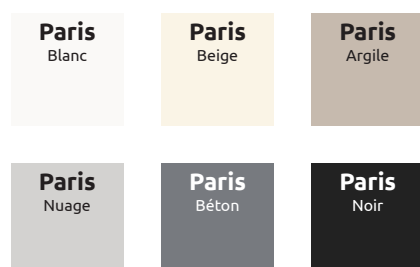

La nuit en plein jour.

Voici une solution ingénieuse, rapide et pratique pour profiter pleinement de la sieste, assombrir la chambre de bébé, couler des nuits paisibles ou... projeter un film en pleine journée dans le noir le plus complet !

Ce store vous offrira :

- **Une protection des regards en toute intimité** : complètement opaque, il bloque complètement la lumière, il vous protégera intégralement des regards indiscrets et fera la nuit noire en plein jour.
- **Une protection de la chaleur pour une fraîcheur printanière** : son traitement clair sur la face extérieure procure à ce film une efficacité incomparable contre le soleil.
- **Il est techniquement possible d'adapter cette toile pour les stores à bandes** mais l'effet black-out sera nettement amoindri à cause du jour entre les bandes.



FILMS AUTOMOBILES

Ces films adhésifs anti chaleur protègent efficacement de la chaleur et des UV provocants la décoloration. La qualité des films apporte la facilité de thermoformage et une glisse exceptionnelle.

Ils rejettent efficacement la chaleur du vitrage des véhicules, préservent des UV et occultent l'intérieur tout en laissant une parfaite transparence vers l'extérieur. Attention, l'utilisation de ces films est orientée pour du verre trempé qui équipe les véhicules. Nous ne conseillons pas de mettre ces films sur des vitrages de bâtiment.

CAR 05 15 25 35 45



Film solaire auto



150 cm



1 à 30 ml

+ High tech

POLYESTER MULTI 60µ



Film Noir transparent :

- Luminosité 5%
- Luminosité 15%
- Luminosité 25%
- Luminosité 35%
- Luminosité 45%

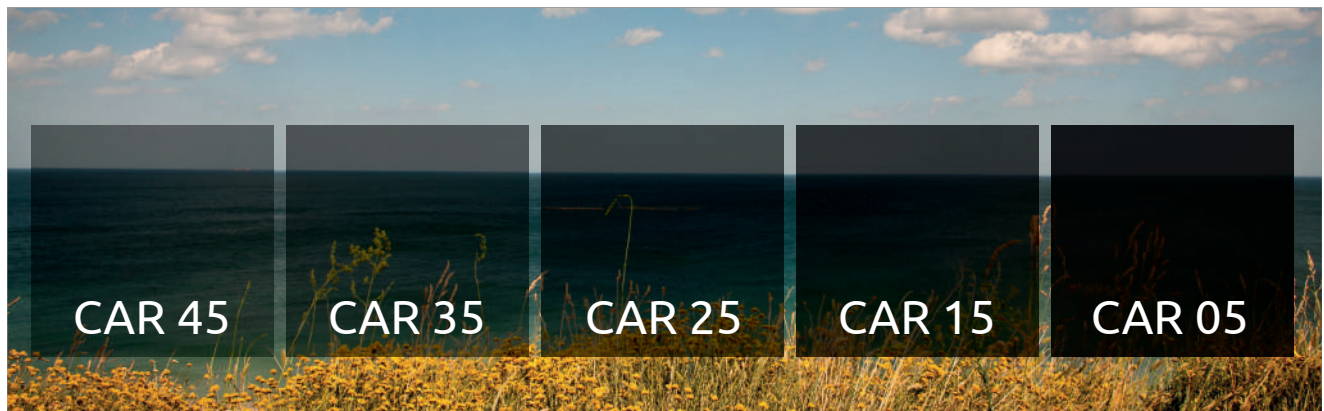



et **Sublim**, deux gammes disponibles :

Au choix !

Pose sur surface lisse et bloquée*



FILM ADHÉSIF



Ils sont idéals pour décorer ou recouvrir vos :

- murs
- meubles
- portes
- têtes de lit
- etc



PLAQUE ALU



80x120cm
100x150cm
120x250cm
et sur mesure

Parfaites à utiliser comme :

- crédence de cuisine
- paroi de salle de bain
- cloisonnement de bureau
- rénovation de mur
- etc

Accessoires alu :



- CORN PL**
Cornière plate
- CORN L**
Cornière en L
- PRF INT**
Profilé coin intérieur
- PRF EXT**
Profilé coin extérieur
- PRF FI**
Profilé de finition
- PRF JC**
Profilé jonction en H

⊕ Les points forts

- Pose à sec
- Lessivable
- Résistant à l'abrasion
- Pose à plat
- Conformable sur surface convexe





L'ensemble de la gamme **HomeStar** est fabriquée dans notre atelier MG Déco, en France.





FABRIQUÉ
EN FRANCE



UNI 610



UNI 672



UNI 675



UNI 694



UNI 670



UNI 680



UNI 625



UNI 621



UNI 620



UNI 633



UNI 632



UNI 631



UNI 630



UNI 645



UNI 641



UNI 646



UNI 665



UNI 647

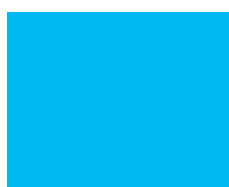

UNI 656



UNI 666



UNI 664



UNI 662



UNI 661



UNI 691



UNI 692





FABRIQUÉ
EN FRANCE



GLT 672

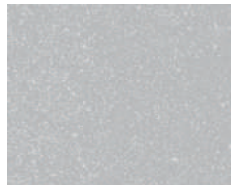

GLT 672



GLT 675

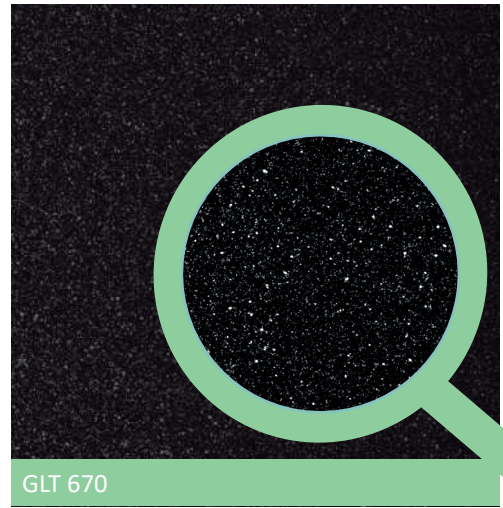

GLT 670

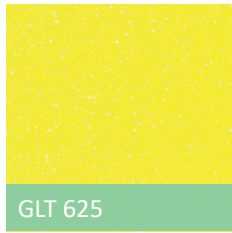

GLT 625



GLT 680



GLT 694



GLT 621



GLT 620



GLT 633



GLT 632



GLT 631



GLT 630



GLT 645



GLT 641



GLT 646



GLT 665



GLT 662



GLT 664



GLT 666



GLT 656



GLT 647



GLT 661



GLT 691



GLT 692

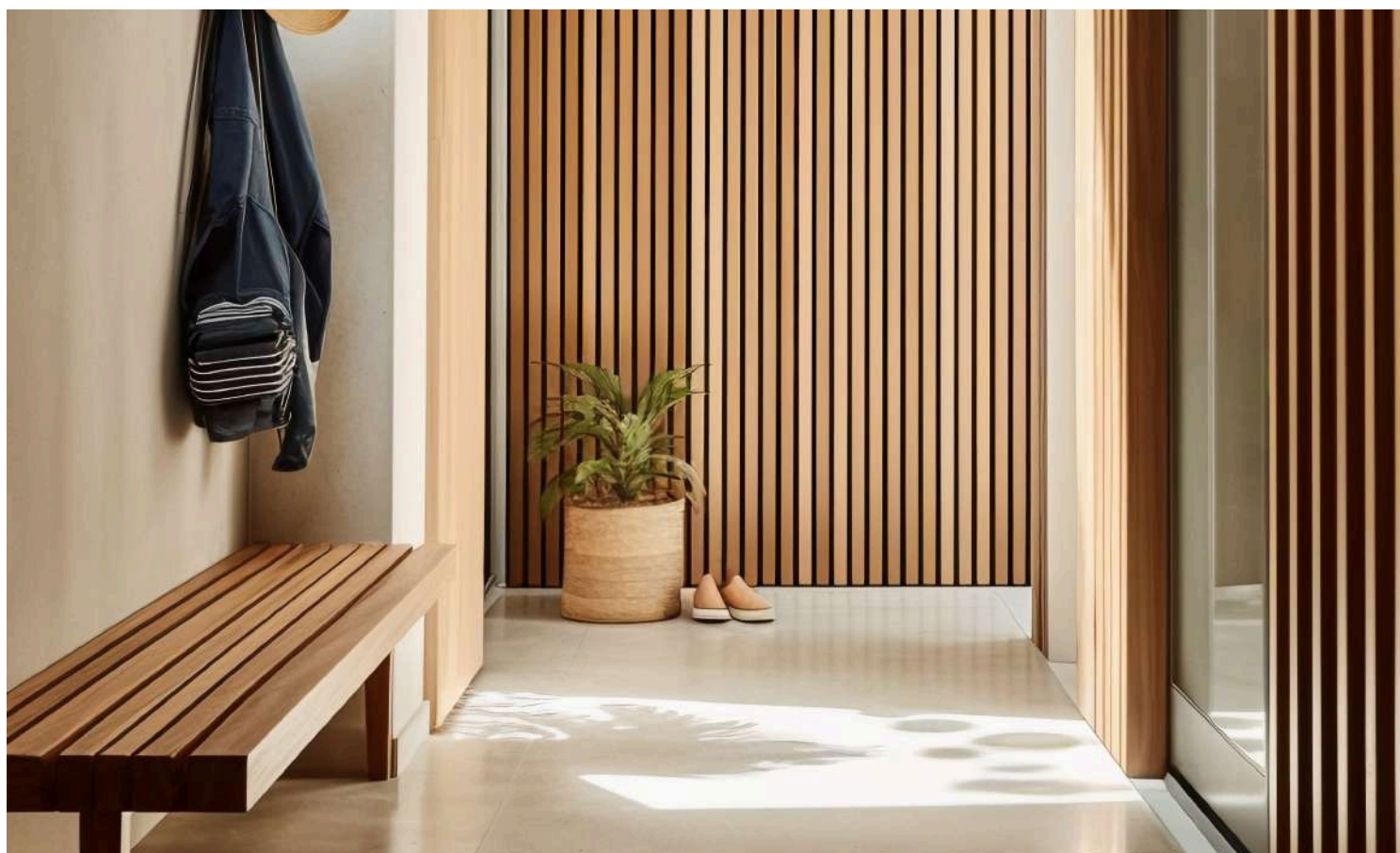

Ce motif de bardage fin est composé de **lattes de 30mm** de large et des **séparations de 12mm**.

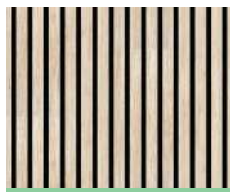

BOIS B30-12-1

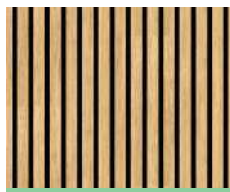

BOIS B30-12-2

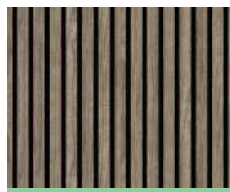

BOIS B30-12-3

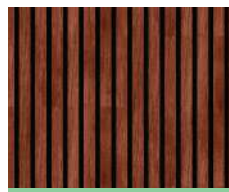

BOIS B30-12-4

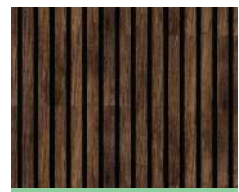

BOIS B30-12-5

Ce motif de bardage medium est composé de **lattes de 56mm** de large et des **séparations de 15mm**.



BOIS B56-15-1



BOIS B56-15-2



BOIS B56-15-3

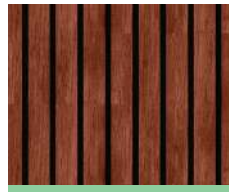

BOIS B56-15-4



BOIS B56-15-5

Ce motif de bardage large est composé de **lattes de 80mm** de large et des **séparations de 20mm**.



BOIS B80-20-1



BOIS B80-20-2



BOIS B80-20-3

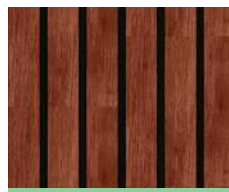

BOIS B80-20-4

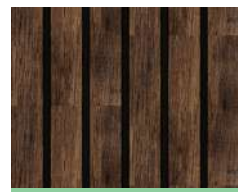

BOIS B80-20-5

Ce motif d'hexagones est composé de **tuiles de 328mm** de haut et des **séparations de 20mm**.



BOIS B328-20-1



BOIS B328-20-2



BOIS B328-20-3



BOIS B328-20-4



BOIS B328-20-5

Ce motif de lattes ce mariera avec tous vos projets.

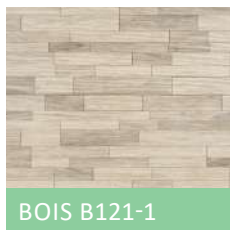

BOIS B121-1

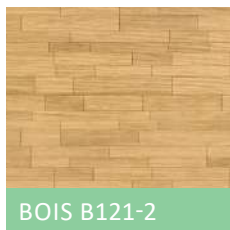

BOIS B121-2



BOIS B121-3

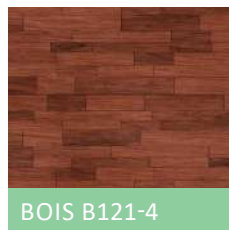

BOIS B121-4

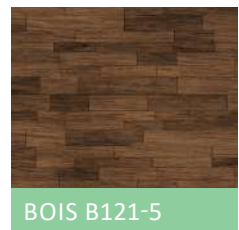

BOIS B121-5



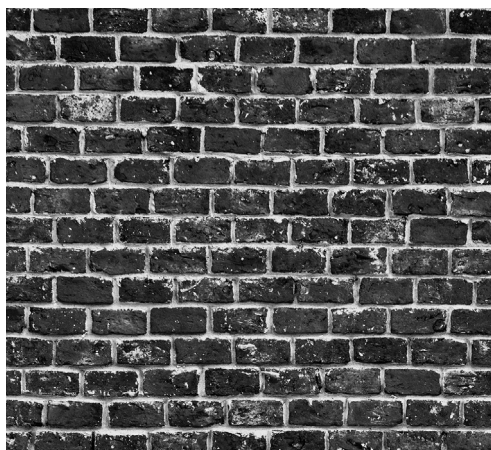

HS 218-1

HAUTEUR BRIQUE 55MM

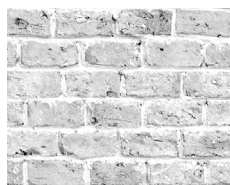

HS 218-2



HS 218-3

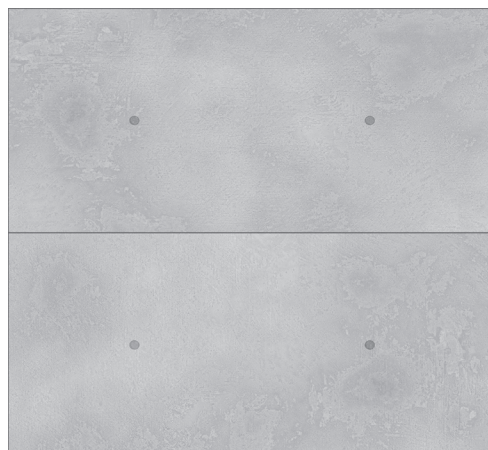

HS 25-1

HAUTEUR PANNEAU 625MM



HS 718-2

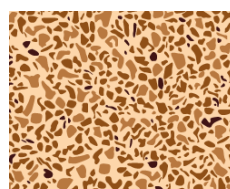

HS 718-1

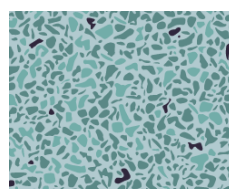

HS 718-3



HS 718-3



HS 718-4



HS 718-4





HS 227-1

RÉPÉTITION MOTIF 3.8M

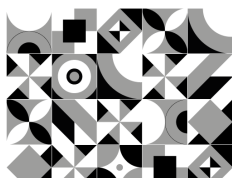

HS 31-1



HS 31-2

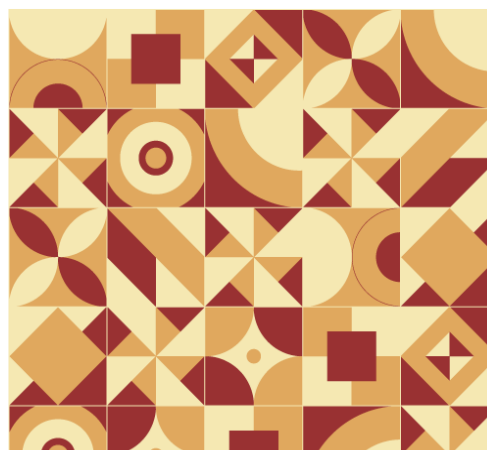

HS 31-3

CARREAU DE MOTIF 12CM



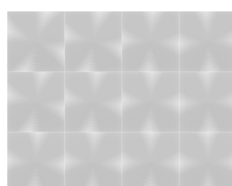

HS 218-1

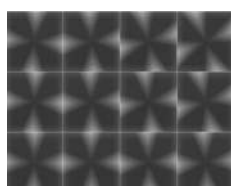

HS 218-2



HS 218-3



HS 218-4

La Gamme
Sublim

Les films **Sublim** de gamme distribution vous sont proposés dans une sélection de plus de 130 modèles.

Pour les VIP du covering :

Découvrez notre collection "**La réserve des Spécialistes**" avec plus de 500 modèles pour combler tous vos désirs de décoration !







BOIS 10-2



BOIS 6-7



BOIS 9-10

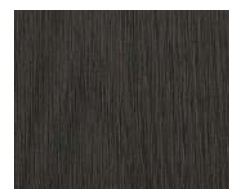

BOIS 320-58



BOIS 146-56



BOIS 10-18



BOIS 12-05

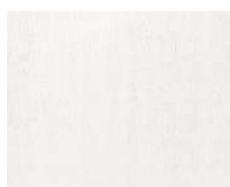

BOIS 10-14

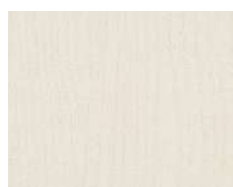

BOIS 10-17

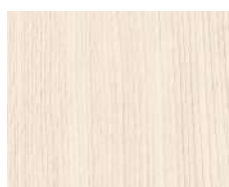

BOIS 112-29



BOIS 146-29

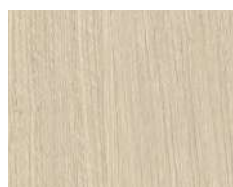

BOIS 46-36



BOIS 2-50



BOIS 146-19



BOIS 9-9



BOIS 146-73

BOIS 148-80



BOIS 8-10

Largeur de latte 86mm

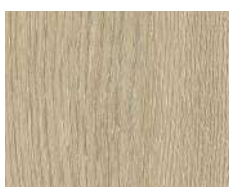

BOIS 146-32



BOIS 148-75

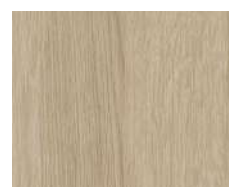

BOIS 145-61

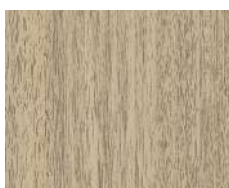

BOIS 148-77

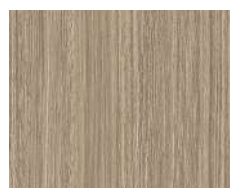

BOIS 148-79

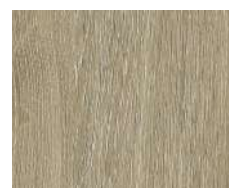

BOIS 146-44



BOIS 320-82

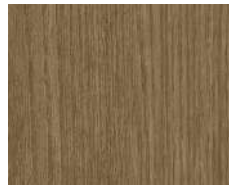

BOIS 17-14



BOIS 17-20



BOIS 146-40



BOIS 146-34



BOIS 2-3



BOIS 112-24

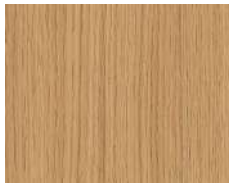

BOIS 16-03



BOIS 9-14



BOIS 146-46



BOIS 4-4



BOIS 148-71



BOIS 146-78

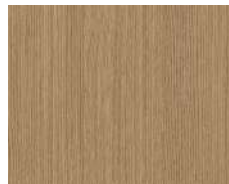

BOIS 2-6

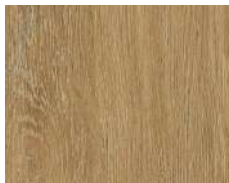

BOIS 146-43



BOIS 6-4

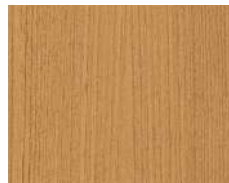

BOIS 2-5



BOIS 320-02



BOIS 146-47



BOIS 145-68

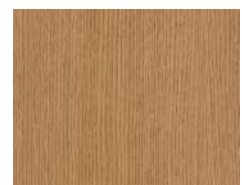

BOIS 2-4



BOIS 148-73



BOIS 2-8

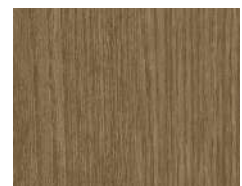

BOIS 126-07



BOIS 8-50 Largeur de latte 75mm

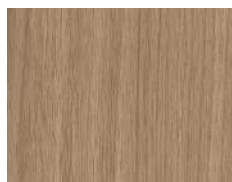

BOIS 16-08



BOIS 146-66



BOIS 320-35

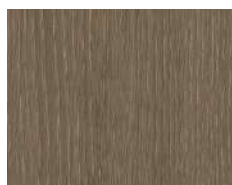

BOIS 320-69



BOIS 145-46

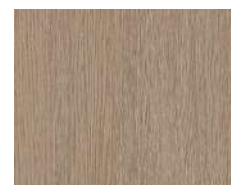

BOIS 7-0



BOIS 112-14

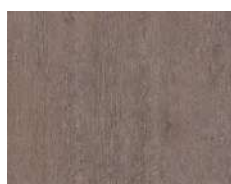

BOIS 11-15



BOIS 146-28



BOIS 7-6 Largeur de latte 86mm



BOIS 2-1

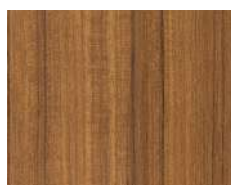

BOIS 120-04



BOIS 6-5

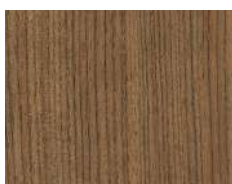

BOIS 16-10

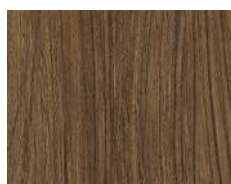

BOIS 11-14



BOIS 4-1



BOIS 8-4 Largeur de latte 40mm



BOIS 146-55



BOIS 5-50



BOIS 6-6



BOIS 146-83







METAL 145-47



METAL 112-09



METAL 17-3

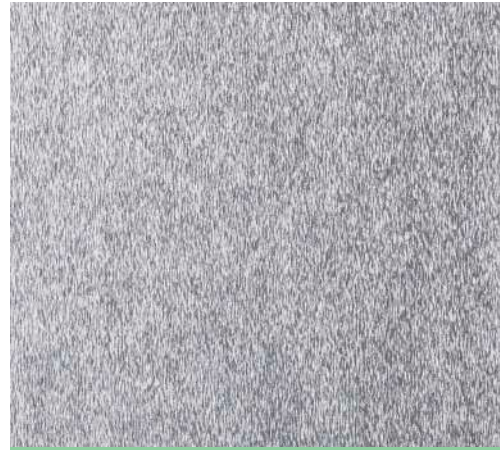

METAL 17-2



METAL 17-50



METAL 148-60



METAL 148-36



METAL 26-2



METAL 145-49



METAL 148-37



METAL 21-10



METAL 23-6





PIER 148-33



PIER 148-54



PIER 21-19



PIER 148-41



PIER 148-40



PIER 145-24



PIER 148-39

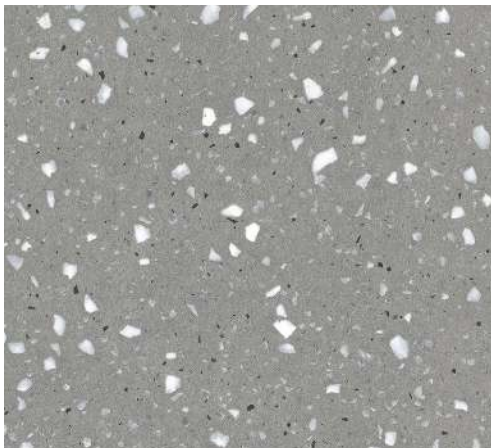

PIER 147-02



PIER 148701



PIER 148-35



PIER 21-21



PIER 21-20



PIER 145-26



PIER 146-99





MARB 145-70



MARB 147-31



MARB 145-72



MARB 145-31



MARB 145-32



MARB 1311-13

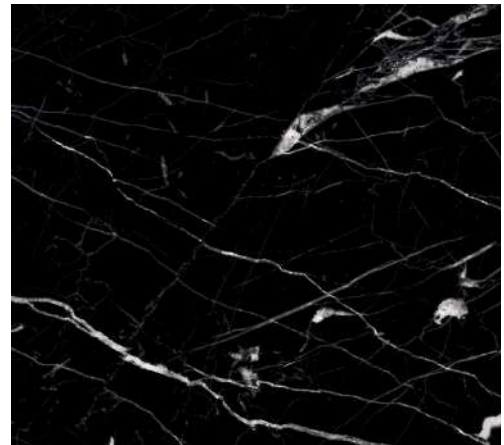

MARB 21-50



MARB 147-04



MARB 148-45



MARB 1311-15



MARB 148-11

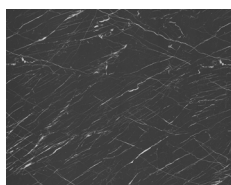

MARB 1311-14



MARB 146-98



MARB 148-46





CUIR 24-51



CUIR 145-40



CUIR 145-42

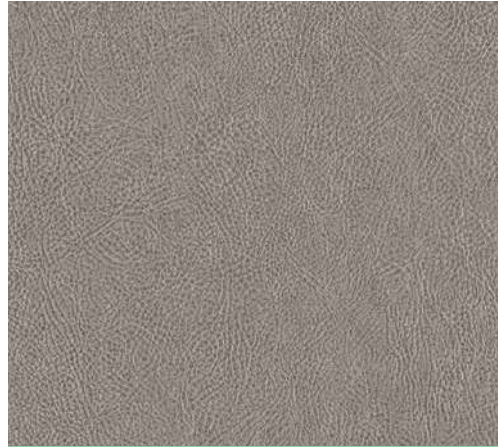

CUIR 145-41



CUIR 24-52





Les films de décorations pour le vitrage sont adhésifs. Ils vous permettront de décorer selon votre goût vos vitrages tout en apportant l'occultation que vous souhaitez en fonction de la densité du motif. Ils seront parfaits pour cloisonner de grands espaces vitrés.

Grâce aux déclinaisons, notre gamme comprend plus de 430 modèles de films adhésifs !

Retrouvez vos motifs :

4D	p 80
Nature	p 86
Courbes	p 97
Vintage	p 104
Abstraites	p 108
Techniques	p 115
Urbains	p 116
Géométrique	p 117
Carrés	p 124
Ombrine & Veni	p 128
Bandes	p 129
Dégressifs	p 139
Concret	p 140



Un grand nombre de motifs au choix !

Choix de la teinte du motif :

- **BL** - Blanc
- **NO** - Noir
- **DP** - Dépoli
- **4D** - Chromatique

Disponible sur :

- **TR** - Film transparent (semi-occultation)
- **DP** - Film dépoli (occultation totale)

Nouveau

Nos films Excellences sont maintenant disponibles en : **150 cm et en 75 cm de large, profitez-en !**

La fabrication est faite en France dans notre atelier, avec des pigments résistants aux UV et à l'abrasion qui respectent l'environnement.

+ Conseil de commande

Références produits :

- **Excel BL** - Motif dépoli blanc
- **Excel DP** - Motif dépoli acide
- **Excel NO** - Motif noir
- **Excel 4D** - Motif chromatique

Lors de votre commande, précisez **TR** pour une impression sur film transparent et **DP** sur film dépoli.

Exemple : Pissenlit BL-DP-150 pour le motif Pissenlit en impression de blanc sur film dépoli de 150cm de large.



Pour tous nos modèles, les dimensions sont :

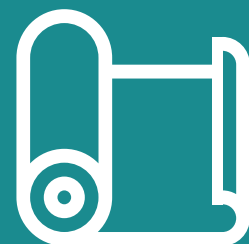

de 1 à 30 m
(par tranche de 50 cm)

Tous nos films sont *posés à l'intérieur* pour une longévité de 10 ans!
Toujours se conformer au DUT 39.

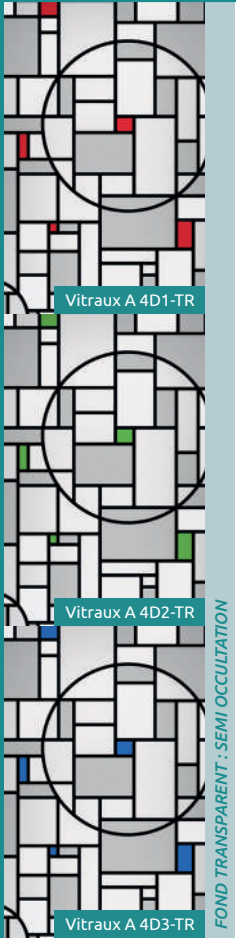

FOND TRANSPARENT : SEMI OCCULTATION

Nouveau

Vitreaux A



Vitreaux A 4D1-TR



75 & 150cm

Répétition motif :

- en 150 : 150cm
- en 75 : 150cm

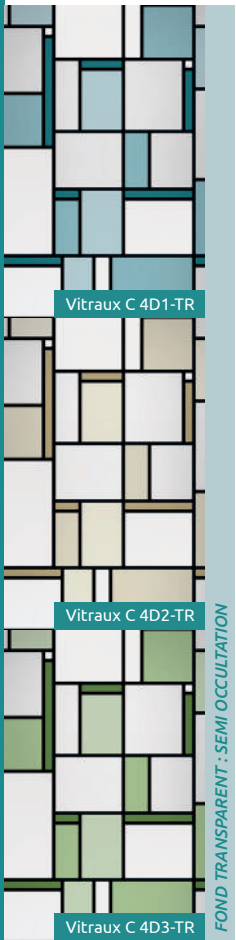
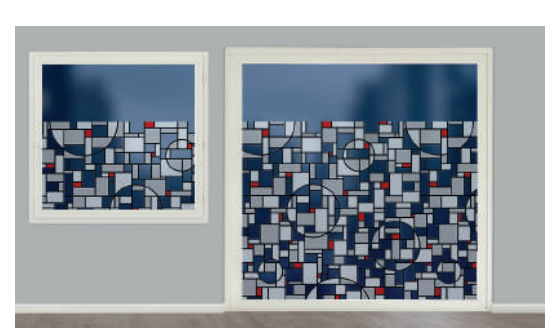

FOND TRANSPARENT : SEMI OCCULTATION

Nouveau

Vitreaux C



Vitreaux C 4D2-TR



75 & 150cm

Répétition motif :

- en 150 : 300cm
- en 75 : 300cm

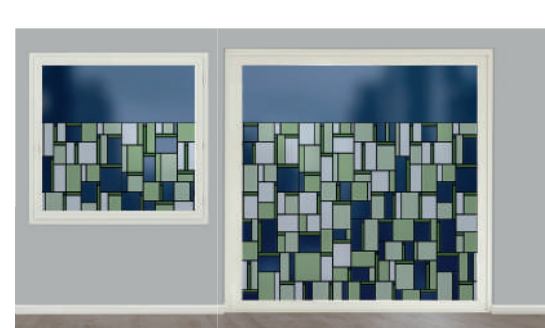

Vitraux B

Nouveau

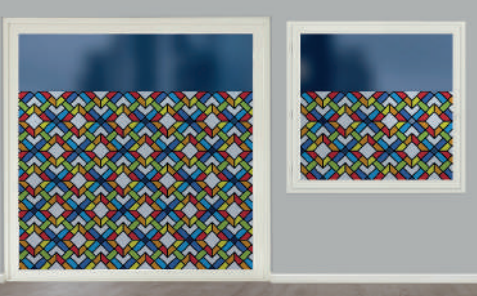

75 & 150cm

Répétition motif :

- en 150 : 37.5cm
- en 75 : 37.5cm

Vitraux B 4D2-TR

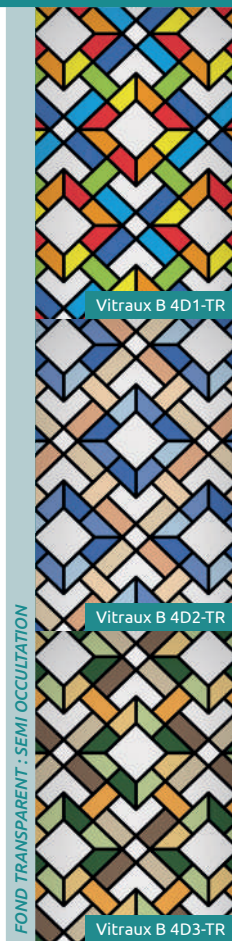

Vitraux B 4D1-TR

Vitraux B 4D2-TR

Vitraux B 4D3-TR

FOND TRANSPARENT - SEMI OCCULTATION

Vitraux D

Nouveau

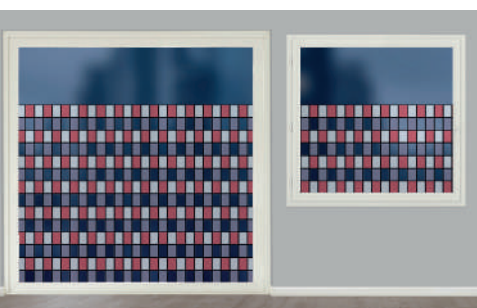
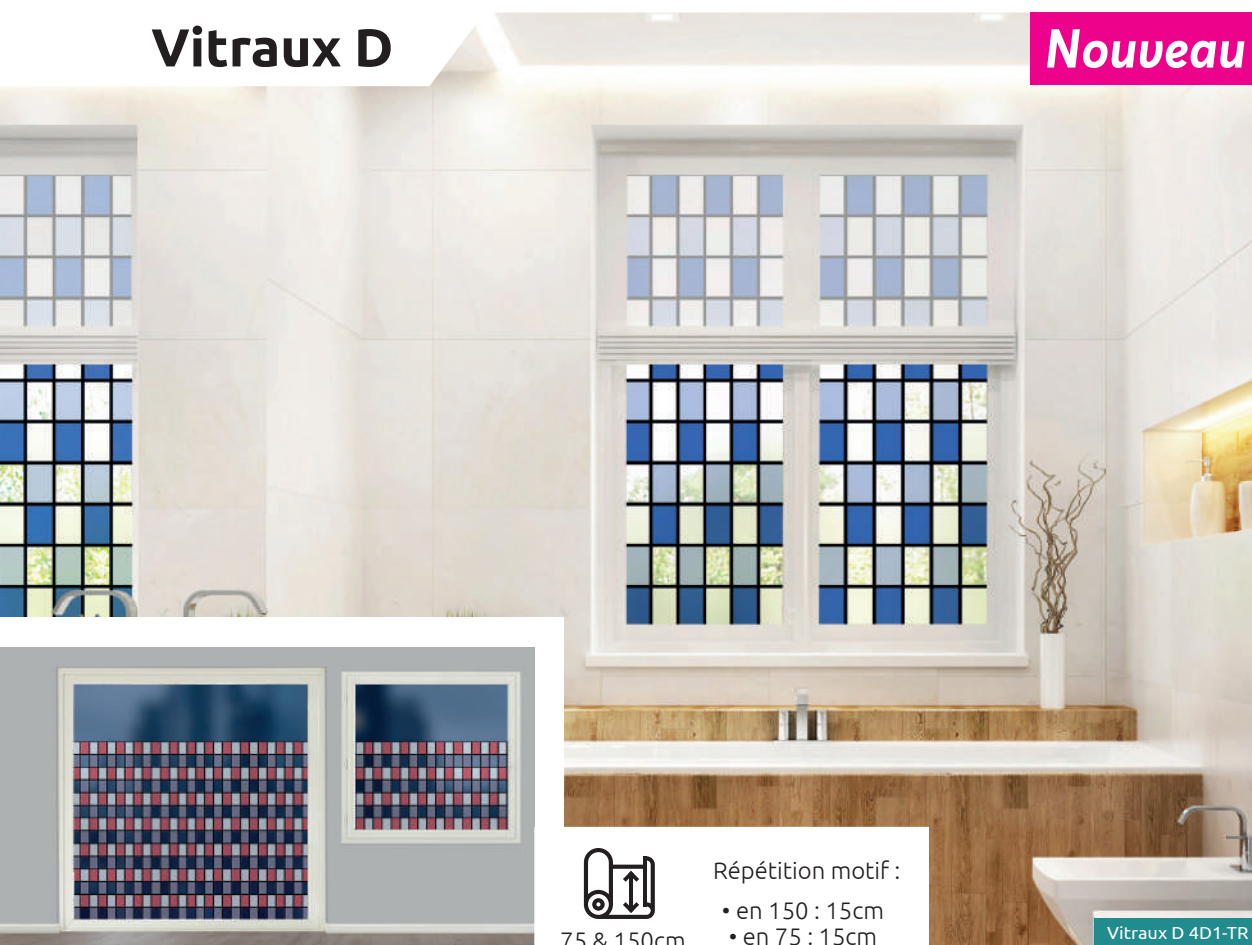

75 & 150cm

Répétition motif :

- en 150 : 15cm
- en 75 : 15cm

Vitraux D 4D1-TR

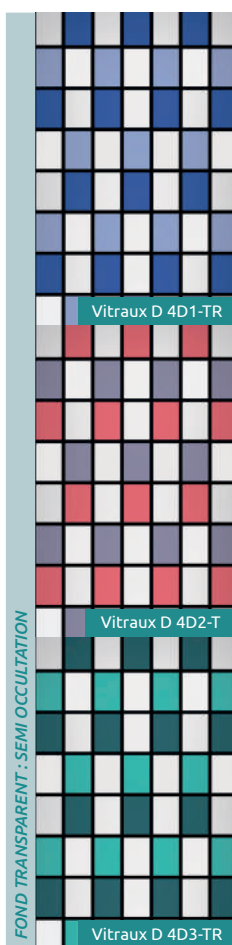

Vitraux D 4D1-TR

Vitraux D 4D2-T

Vitraux D 4D3-TR

FOND TRANSPARENT - SEMI OCCULTATION

Les « Excellence » : Motifs 4D

Subway

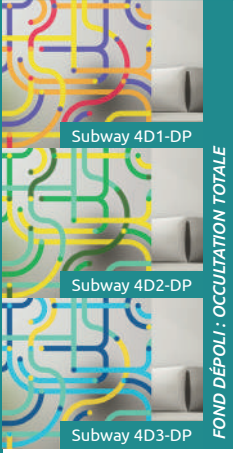

FOND DÉPOLI : OCCULTATION TOTALE



FOND TRANSPARENT : SEMI OCCULTATION



75 & 150cm

Répétition motif :

- en 150 : 300cm
- en 75 : 150cm



FOND DÉPOLI : OCCULTATION TOTALE

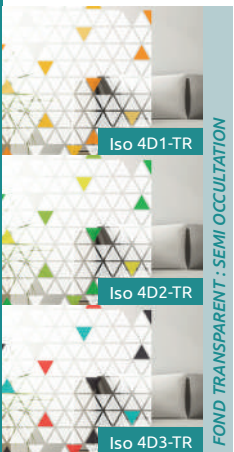

FOND TRANSPARENT : SEMI OCCULTATION



75 & 150cm

Répétition motif :

- en 150 : 192cm
- en 75 : 96cm

Iso

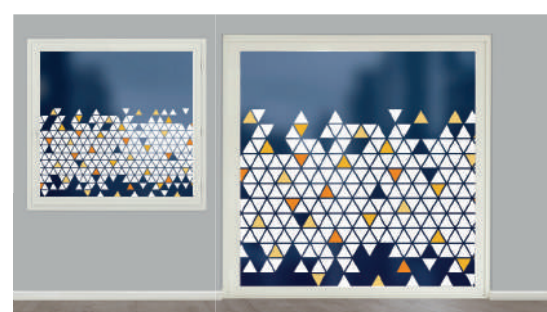

Kovic

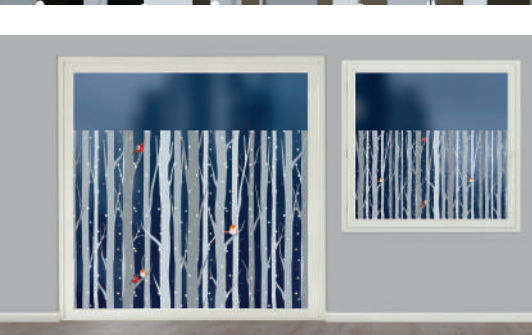

Répétition motif :
 • en 150 : 150cm
 • en 75 : 75cm

Kovic 4D1-DP

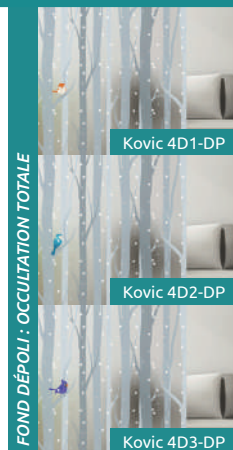

Party



Répétition motif :
 • en 150 : 82cm
 • en 75 : 41cm

Party 4D1-TR



Les « Excellence » : Motifs 4D

Pollock

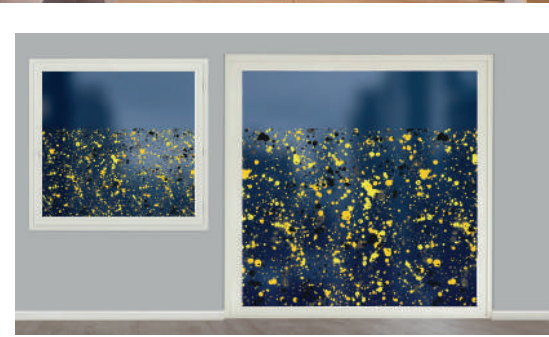
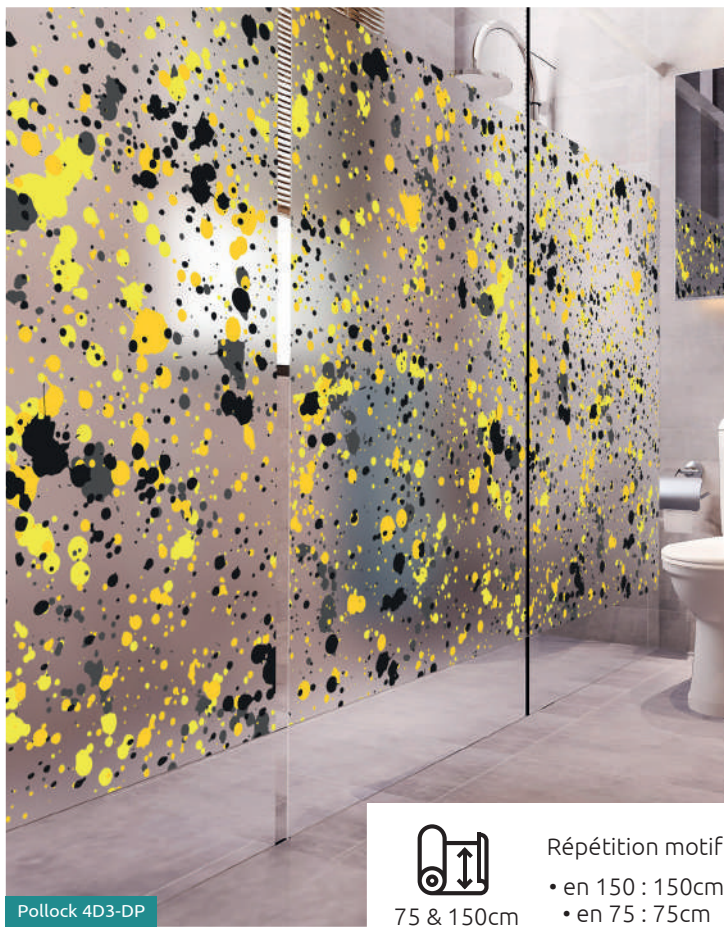
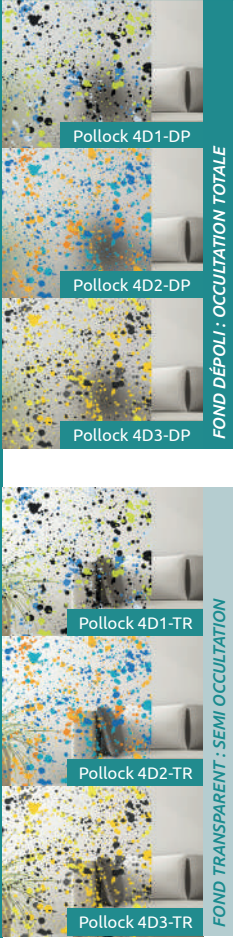

75 & 150cm

Répétition motif :

- en 150 : 150cm
- en 75 : 75cm

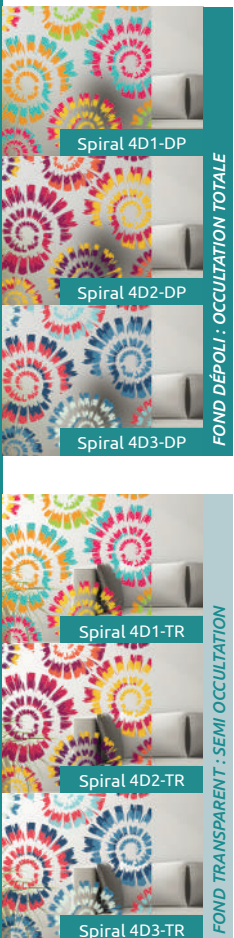

Spiral

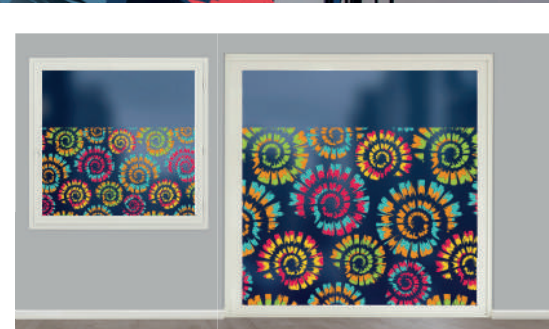

75 & 150cm

Répétition motif :

- en 150 : 150cm
- en 75 : 75cm

Pixels

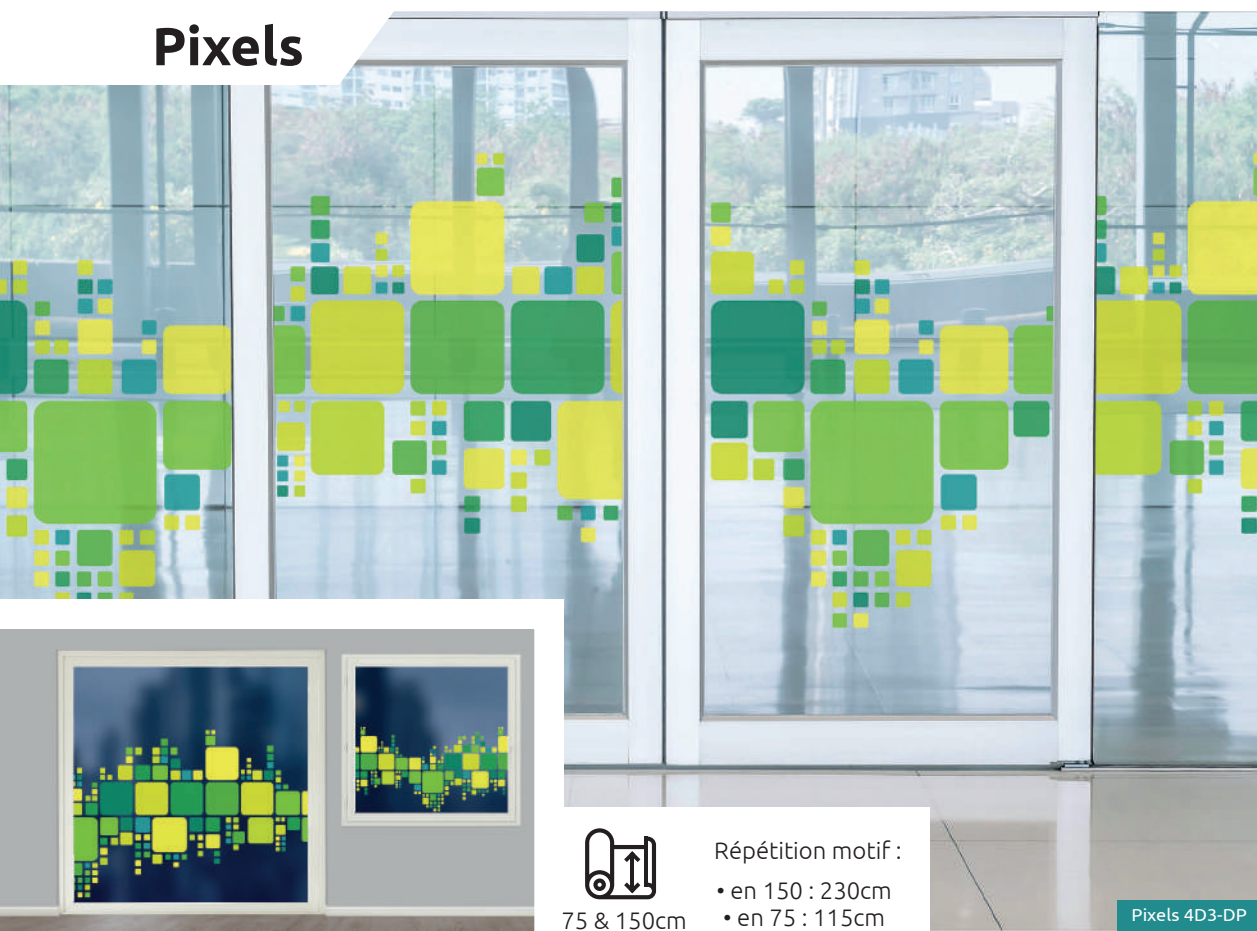

Répétition motif :
 • en 150 : 230cm
 • en 75 : 115cm

Pixels 4D3-DP



Verger



Répétition motif :
 • en 150 : 150cm
 • en 75 : 75cm

Verger 4D2-DP



Les « Excellence » : Motifs 4D

Jungle



Jungle NO-DP



Jungle BL-DP

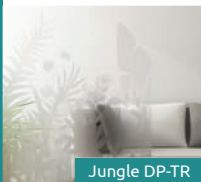

Jungle DP-TR

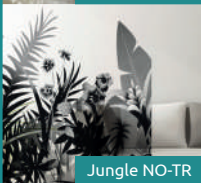

Jungle NO-TR

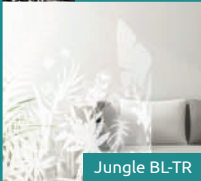

Jungle BL-TR

FOND DÉPOLI : OCCULTATION TOTALE

FOND TRANSPARENT : SEMI OCCULTATION



Jungle NO-TR



75 & 150cm

Répétition motif :

- en 150 : 252cm
- en 75 : 126cm



Pissenlit NO-DP



Pissenlit BL-DP



Pissenlit DP-TR



Pissenlit NO-TR



Pissenlit BL-TR

FOND DÉPOLI : OCCULTATION TOTALE

FOND TRANSPARENT : SEMI OCCULTATION



Pissenlit BL-DP



75 & 150cm

Répétition motif :

- en 150 : 156cm
- en 75 : 78cm



Pissenlit



Fougère



Répétition motif :

- en 150 : 420cm
- en 75 : 210cm

75 & 150cm

Fougère BL-TR

FOND DÉPOLI : OCCULTATION TOTALE



Fougère NO-DP



Fougère BL-DP

FOND TRANSPARENT : SEMI OCCULTATION



Fougère DP-TR



Fougère NO-TR



Fougère BL-TR

Les « Excellence » : Motifs Nature

Montagne

Nouvelle Version



Répétition motif :

- en 150 : 504cm
- en 75 : 252cm

75 & 150cm

Montagne BL-TR

FOND DÉPOLI : OCCULTATION TOTALE



Montagne NO-DP

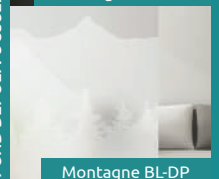

Montagne BL-DP

FOND TRANSPARENT : SEMI OCCULTATION



Montagne DP-TR

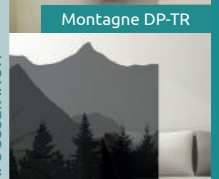

Montagne NO-TR

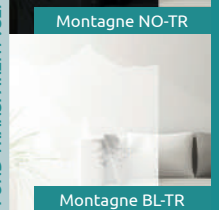

Montagne BL-TR

Bambou



75 & 150cm

Répétition motif :

- en 150 : 255cm
- en 75 : 127.5cm



Savane

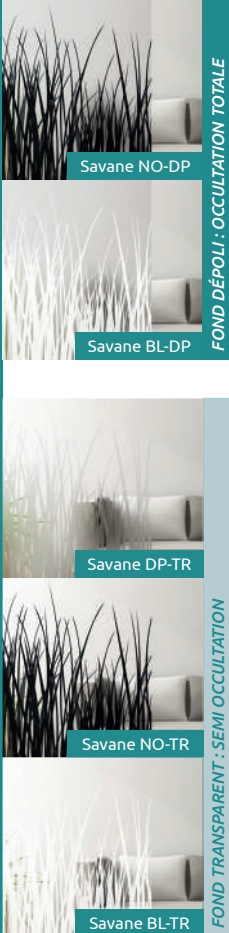

75 & 150cm

Répétition motif :

- en 150 : 79cm
- en 75 : 39.5cm



Blé



 Répétition motif :
 • en 150 : 150cm
 • en 75 : 75cm

Blé BL-DP

FOND DÉPOLI : OCCULTATION TOTALE



Blé NO-DP



Blé BL-DP

FOND TRANSPARENT : SEMI OCCULTATION



Blé DP-TR



Blé NO-TR



Blé BL-TR

Champêtre



 Répétition motif :
 • en 150 : 79cm
 • en 75 : 39.5cm

Champêtre BL-TR

FOND DÉPOLI : OCCULTATION TOTALE



Champêtre NO-DP



Champêtre BL-DP

FOND TRANSPARENT : SEMI OCCULTATION



Champêtre DP-TR



Champêtre NO-TR



Champêtre BL-TR

Les « Excellence » : Motifs Nature

Palma

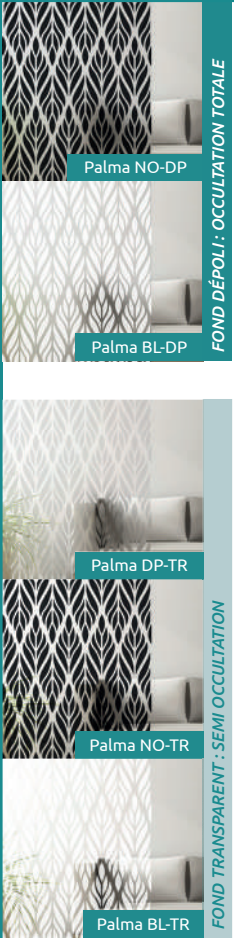

FOND DÉPOLI : OCCULTATION TOTALE

FOND TRANSPARENT : SEMI OCCULTATION



75 & 150cm

Répétition motif :

- en 150 : 23cm
- en 75 : 11.5cm

Palma Inv BL-TR

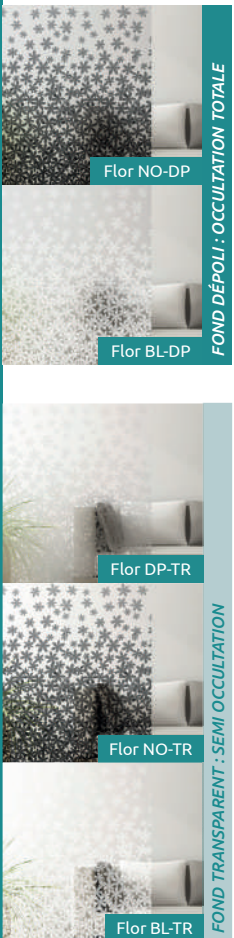

FOND DÉPOLI : OCCULTATION TOTALE

FOND TRANSPARENT : SEMI OCCULTATION



Flor



75 & 150cm

Répétition motif :

- en 150 : 50cm
- en 75 : 25cm

Flor NO-TR

Maeri



 Répétition motif :
 • en 150 : 120cm
 • en 75 : 60cm

75 & 150cm

Maeri BL-TR

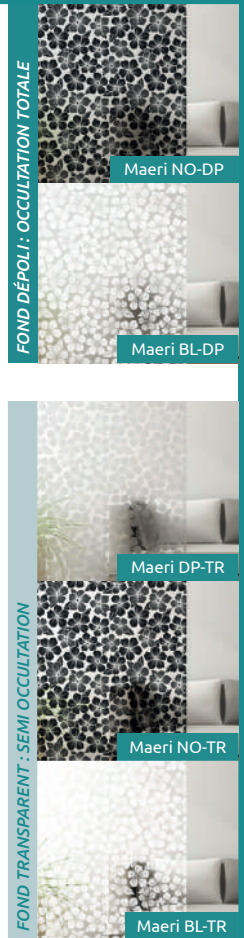

Tropical

Nouveau



 Répétition motif :
 • en 150 : 150cm
 • en 75 : 75cm

75 & 150cm

Tropical BL-DP

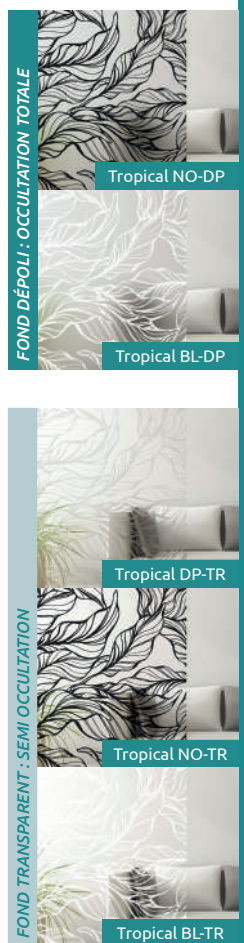

Les « Excellence » : Motifs Nature

Arbre

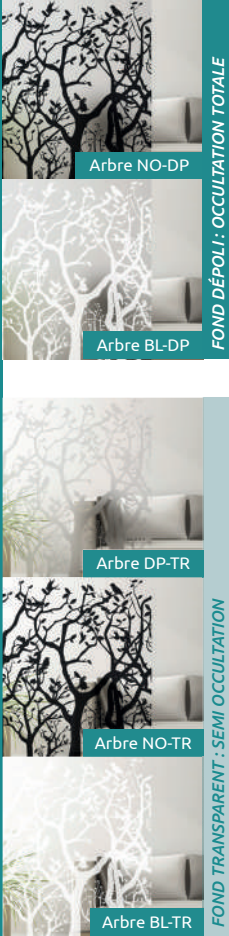

FOND DÉPOLI : OCCULTATION TOTALE

FOND TRANSPARENT : SEMI OCCULTATION



Arbre BL-DP



75 & 150cm

Répétition motif :

- en 150 : 192cm
- en 75 : 96cm



Nouveau

Bornéo

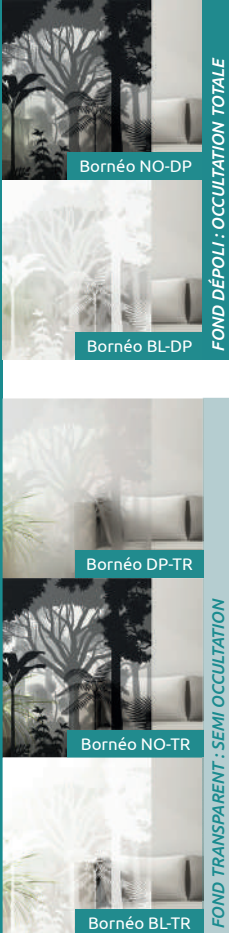

FOND DÉPOLI : OCCULTATION TOTALE

FOND TRANSPARENT : SEMI OCCULTATION



Bornéo BL-DP



75 & 150cm

Répétition motif :

- en 150 : 400cm
- en 75 : 200cm



Cerisiers



Répétition motif :
 • en 150 : 330cm
 • en 75 : 165cm

Cerisiers NO-DP

FOND DÉPOLI : OCCULTATION TOTALE



Cerisiers NO-DP



Cerisiers BL-DP

FOND TRANSPARENT : SEMI OCCULTATION



Cerisiers DP-TR



Cerisiers NO-TR



Cerisiers BL-TR

Stère

Nouveau



Répétition motif :
 • en 150 : 300cm
 • en 75 : 150cm

Stère BL-TR

FOND DÉPOLI : OCCULTATION TOTALE



Stère NO-DP



Stère BL-DP

FOND TRANSPARENT : SEMI OCCULTATION



Stère DP-TR



Stère NO-TR



Stère BL-TR

Les « Excellence » : Motifs Nature

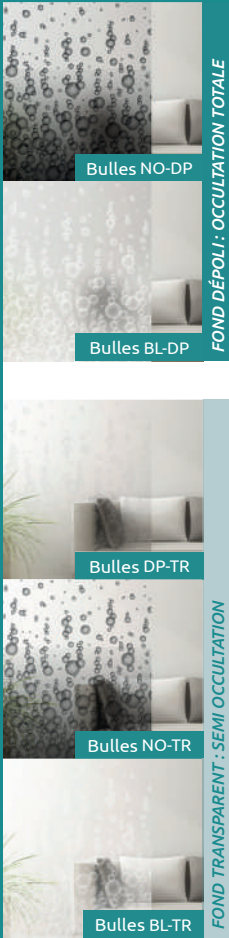

Nouveau



Bulles

Bulles BL-TR



75 & 150cm

Répétition motif :

- en 150 : 150cm
- en 75 : 75cm

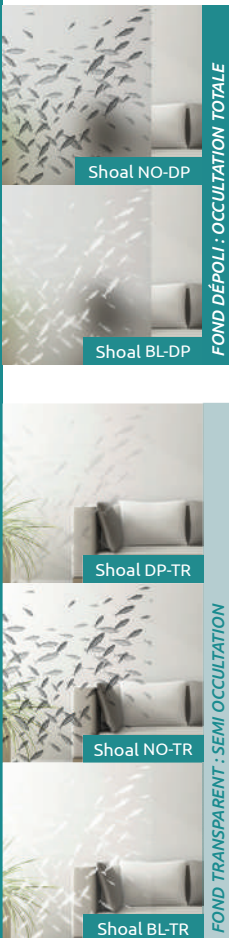

Nouveau



Shoal

Shoal BL-DP



75 & 150cm

Répétition motif :

- en 150 : 300cm
- en 75 : 150cm



Papillon



 Répétition motif :
 • en 150 : 92cm
 • en 75 : 46cm

Papillon BL-DP

FOND DÉPOLI : OCCULTATION TOTALE



Papillon NO-DP



Papillon BL-DP

FOND TRANSPARENT : SEMI OCCULTATION

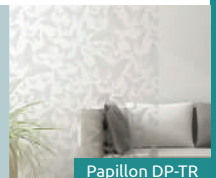

Papillon DP-TR

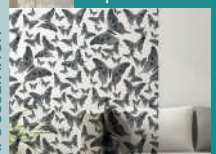

Papillon NO-TR



Papillon BL-TR

Raies

Nouveau

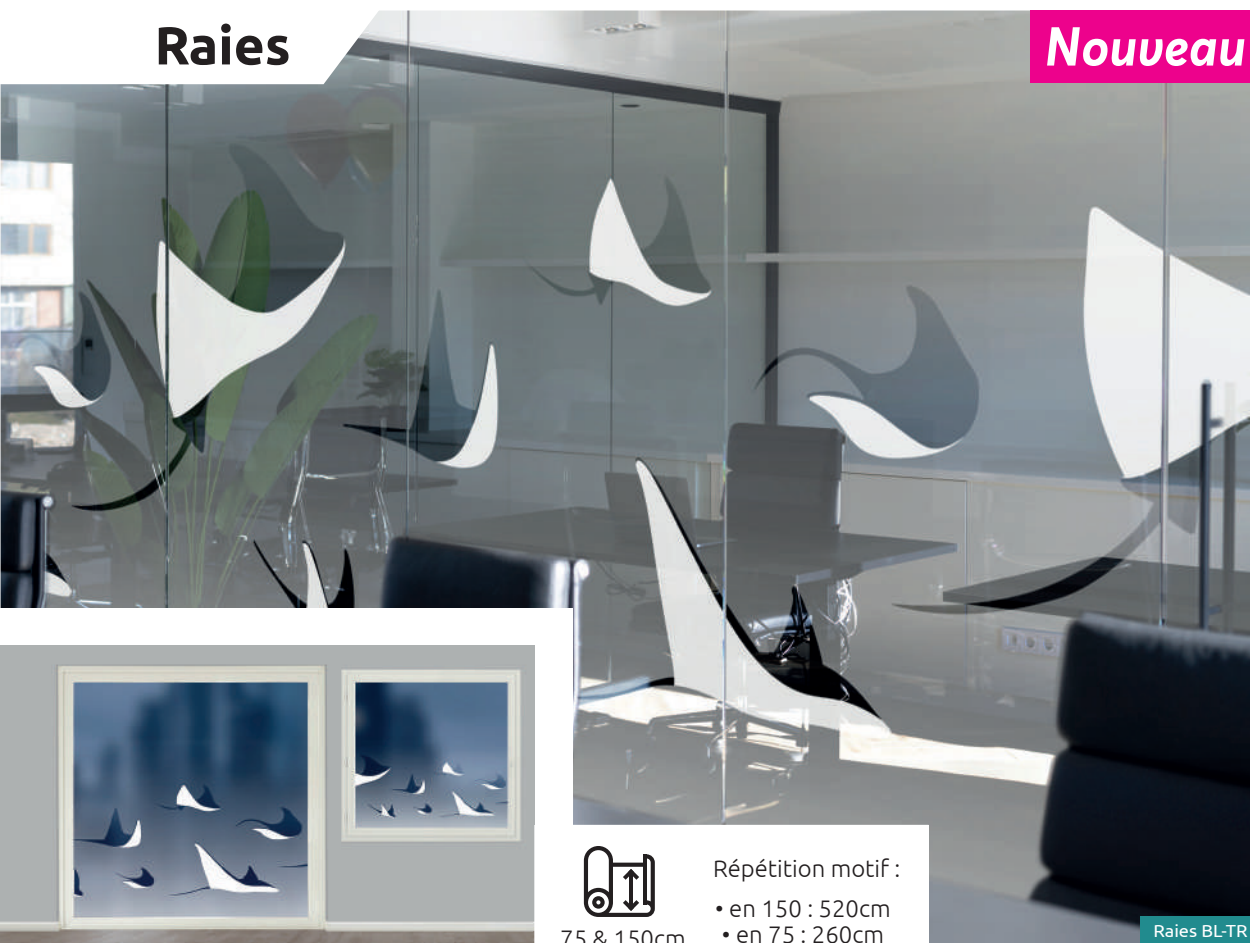

 Répétition motif :
 • en 150 : 520cm
 • en 75 : 260cm

Raies BL-TR

FOND DÉPOLI : OCCULTATION TOTALE

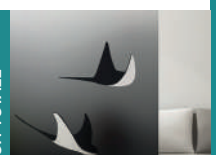

Raies NO-DP



Raies BL-DP

FOND TRANSPARENT : SEMI OCCULTATION

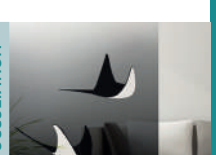

Raies NO-TR

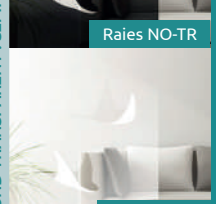

Raies BL-TR

Les « Excellence » : Motifs Nature

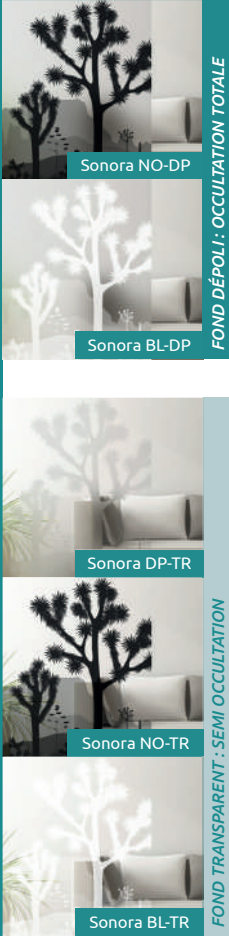

FOND DÉPOLI : OCCULTATION TOTALE

FOND TRANSPARENT : SEMI OCCULTATION

Nouveau

Sonora



Répétition motif :
 • en 150 : 240cm
 • en 75 : 120cm

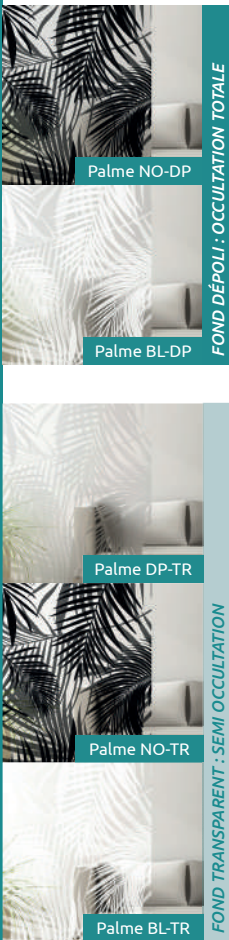

FOND DÉPOLI : OCCULTATION TOTALE

FOND TRANSPARENT : SEMI OCCULTATION

Nouveau

Palme



Répétition motif :
 • en 150 : 300cm
 • en 75 : 150cm





Zarha



75 & 150cm

Répétition motif :

- en 150 : 68cm
- en 75 : 34cm

Zarha BL-DP

FOND DÉPOLI : OCCULTATION TOTALE

Zarha NO-DP

Zarha BL-DP

FOND TRANSPARENT : SEMI OCCULTATION

Zarha DP-TR

Zarha NO-TR

Zarha BL-TR

Les « Excellence » : Motifs Nature & Courbes

Fleuve

Nouveau



75 & 150cm

Répétition motif :

- en 150 : 300cm
- en 75 : 150cm

Fleuve BL-TR

FOND DÉPOLI : OCCULTATION TOTALE

Fleuve NO-DP

Fleuve BL-DP

FOND TRANSPARENT : SEMI OCCULTATION

Fleuve DP-TR

Fleuve NO-TR

Fleuve BL-TR

Vague



FOND DÉPOLI : OCCULTATION TOTALE



FOND TRANSPARENT : SEMI OCCULTATION



75 & 150cm

Répétition motif :

- en 150 : 22cm
- en 75 : 11cm

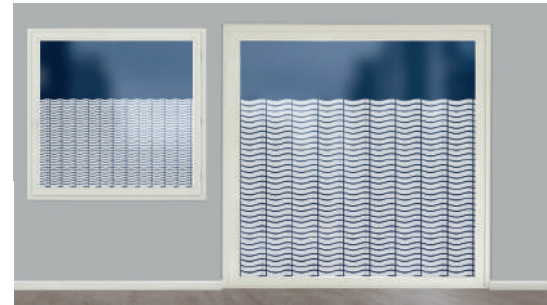

FOND DÉPOLI : OCCULTATION TOTALE



FOND TRANSPARENT : SEMI OCCULTATION



Voile



75 & 150cm

Répétition motif :

- en 150 : 300cm
- en 75 : 150cm





Flo



75 & 150cm

Répétition motif :

- en 150 : 22cm
- en 75 : 11cm

Flo DP-TR

FOND DÉPOLI : OCCULTATION TOTALE

Flo NO-DP

Flo BL-DP

FOND TRANSPARENT : SEMI OCCULTATION

Flo NO-TR

Flo BL-TR

Empreinte



75 & 150cm

Répétition motif :

- en 150 : 225cm
- en 75 : 112.5cm

Empreinte BL-TR

FOND DÉPOLI : OCCULTATION TOTALE

Empreinte NO-DP

Empreinte BL-DP

FOND TRANSPARENT : SEMI OCCULTATION

Empreinte DP-TR

Empreinte NO-TR

Empreinte BL-TR

Les « Excellence » : Motifs Courbes

Chimère

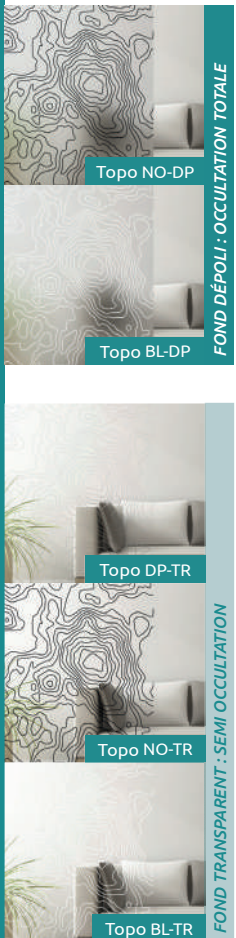
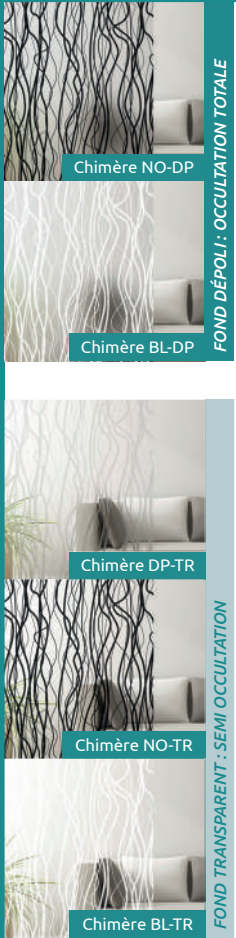

Topo



Mistral



 Répétition motif :
 • en 150 : 22cm
 • en 75 : 11cm

75 & 150cm

Mistral BL-DP

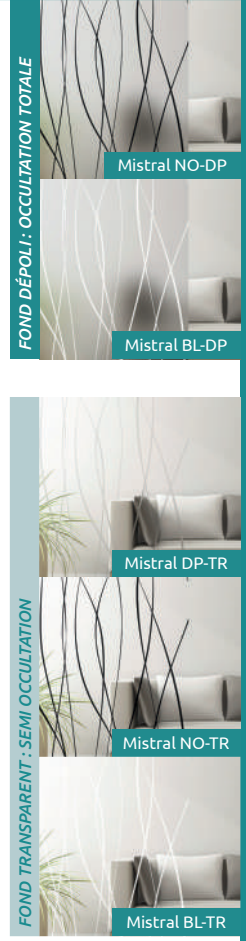

Fils



 Répétition motif :
 • en 150 : 300cm
 • en 75 : 150cm

75 & 150cm

Fils BL-DP

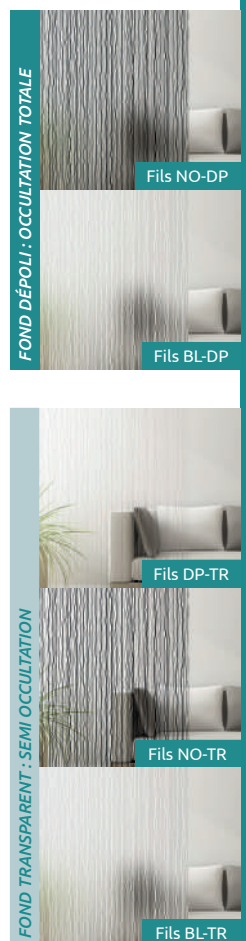

Les « Excellence » : Motifs Courbes

Dune

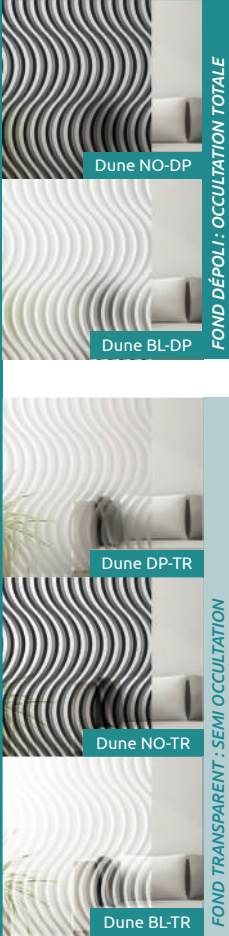

FOND DÉPOLI : OCCULTATION TOTALE

FOND TRANSPARENT : SEMI OCCULTATION



75 & 150cm

Répétition motif :

- en 150 : 49cm
- en 75 : 24.5cm

Dune NO-DP

Nouveau

Kaiso

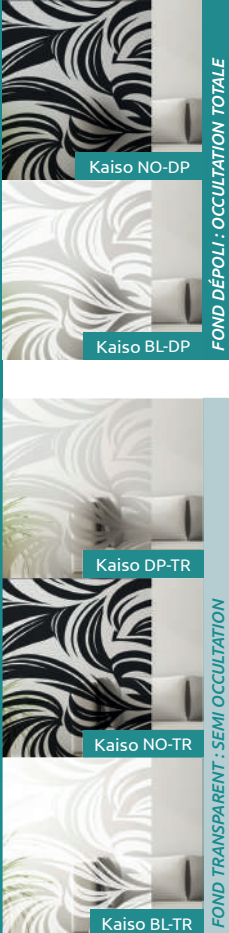

FOND DÉPOLI : OCCULTATION TOTALE

FOND TRANSPARENT : SEMI OCCULTATION



75 & 150cm

Répétition motif :

- en 150 : 300cm
- en 75 : 150cm

Kaiso BL-DP

Duline

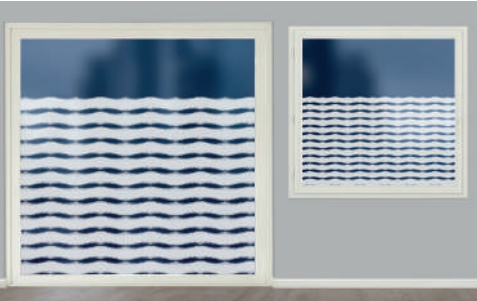
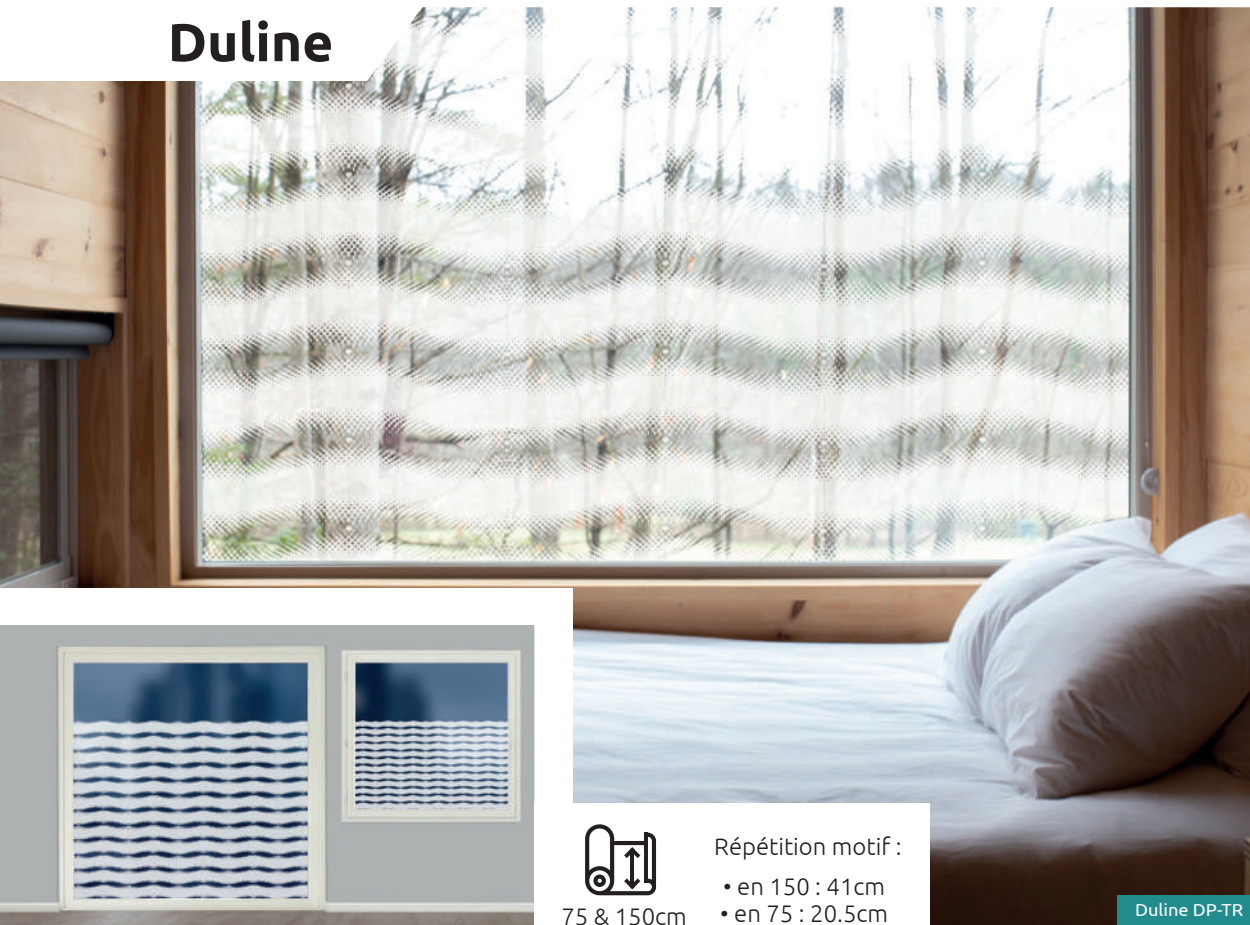

75 & 150cm

Répétition motif :

- en 150 : 41cm
- en 75 : 20.5cm

Duline DP-TR

FOND DÉPOLI : OCCULTATION TOTALE



Duline NO-DP

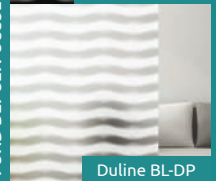

Duline BL-DP

FOND TRANSPARENT : SEMI OCCULTATION



Duline DP-TR



Duline NO-TR



Duline BL-TR

Synth

Nouveau



75 & 150cm

Répétition motif :

- en 150 : 300cm
- en 75 : 150cm

Synth BL-DP

FOND DÉPOLI : OCCULTATION TOTALE



Synth NO-DP



Synth BL-DP

FOND TRANSPARENT : SEMI OCCULTATION



Synth DP-TR



Synth NO-TR



Synth BL-TR

Les « Excellence » : Motifs Courbes

Retro



FOND DÉPOLI : OCCULTATION TOTALE



FOND TRANSPARENT : SEMI OCCULTATION



75 & 150cm

Répétition motif :

- en 150 : 183cm
- en 75 : 91.5cm



FOND DÉPOLI : OCCULTATION TOTALE

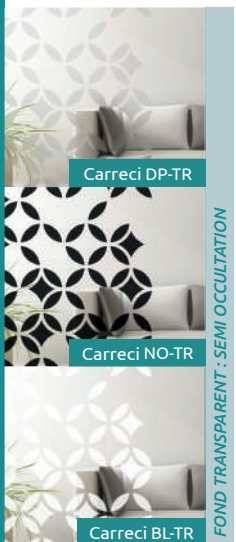

FOND TRANSPARENT : SEMI OCCULTATION



75 & 150cm

Répétition motif :

- en 150 : 300cm
- en 75 : 150cm

Carreci



Suni



 Répétition motif :
 • en 150 : 50cm
 • en 75 : 25cm

75 & 150cm

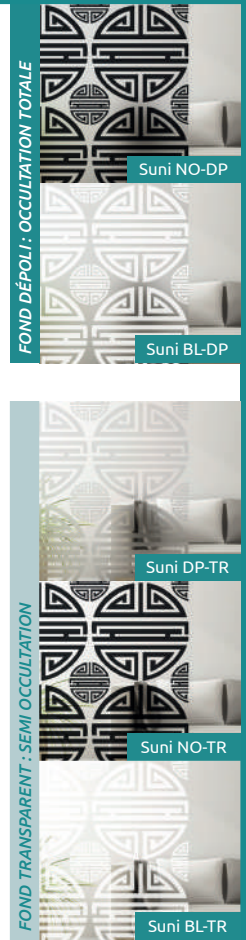

FOND DÉPOLI : OCCULTATION TOTALE

FOND TRANSPARENT : SEMI OCCULTATION

Anneau



 Répétition motif :
 • en 150 : 156cm
 • en 75 : 78cm

75 & 150cm

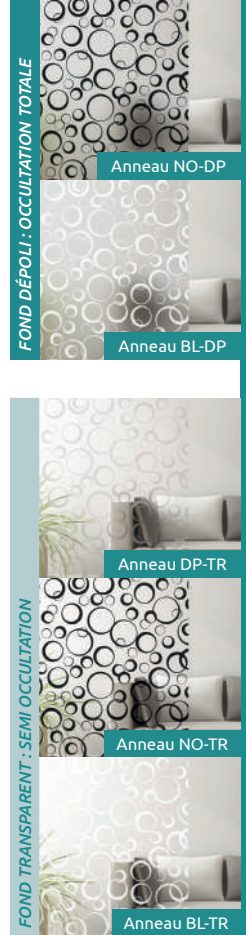

FOND DÉPOLI : OCCULTATION TOTALE

FOND TRANSPARENT : SEMI OCCULTATION

Les « Excellence » : Motifs Vintage

Chaîne

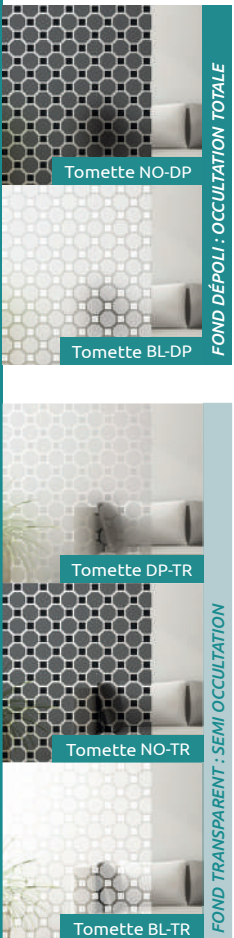

Tomette



Ténééré

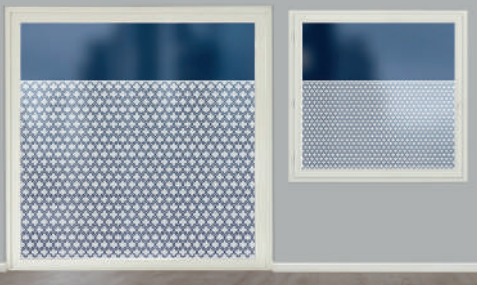

Répétition motif :
 • en 150 : 8cm
 • en 75 : 4cm

Ténééré BL-TR

FOND DÉPOLI : OCCULTATION TOTALE



Ténééré NO-DP



Ténééré BL-DP

FOND TRANSPARENT : SEMI OCCULTATION



Ténééré DP-TR

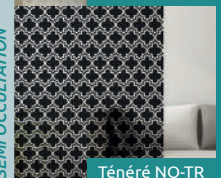

Ténééré NO-TR



Ténééré BL-TR

Circle

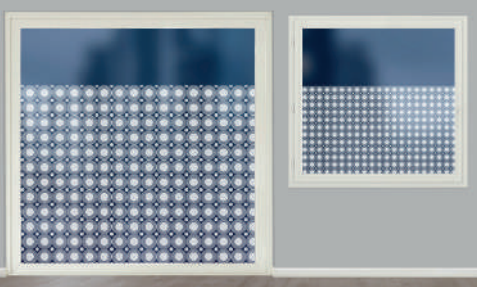

Répétition motif :
 • en 150 : 13cm
 • en 75 : 6.5cm

Circle NO-TR

FOND DÉPOLI : OCCULTATION TOTALE



Circle NO-DP



Circle BL-DP

FOND TRANSPARENT : SEMI OCCULTATION

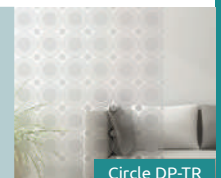

Circle DP-TR



Circle NO-TR



Circle BL-TR

Les « Excellence » : Motifs Vintage

Artifice

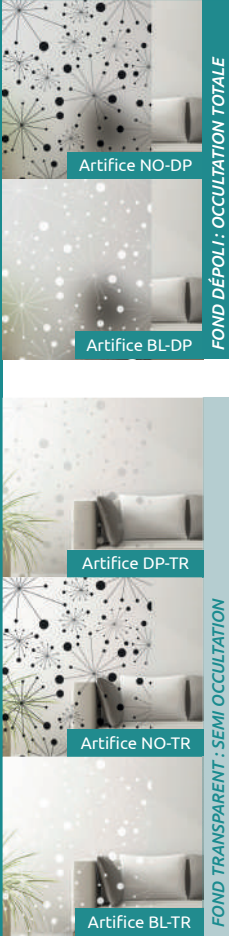

75 & 150cm

Répétition motif :

- en 150 : 185cm
- en 75 : 92.5cm

Nouveau

Pearls

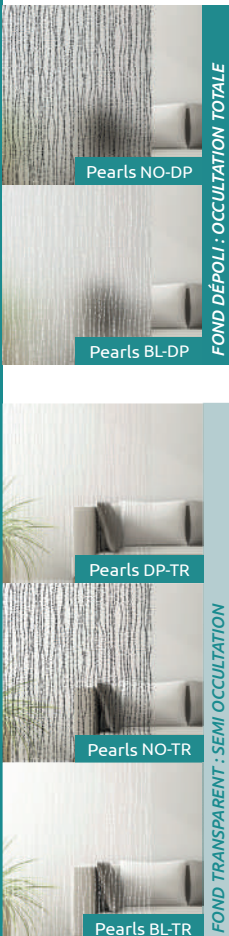

75 & 150cm

Répétition motif :

- en 150 : 300cm
- en 75 : 150cm

Scratchi

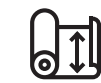

75 & 150cm

Répétition motif :

- en 150 : 600cm
- en 75 : 300cm

Scratchi NO-TR

FOND DÉPOLI : OCCULTATION TOTALE

Scratchi NO-DP

Scratchi BL-DP

FOND TRANSPARENT : SEMI OCCULTATION

Scratchi DP-TR

Scratchi NO-TR

Scratchi BL-TR

Tracks

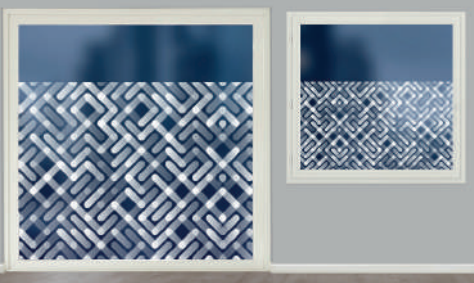
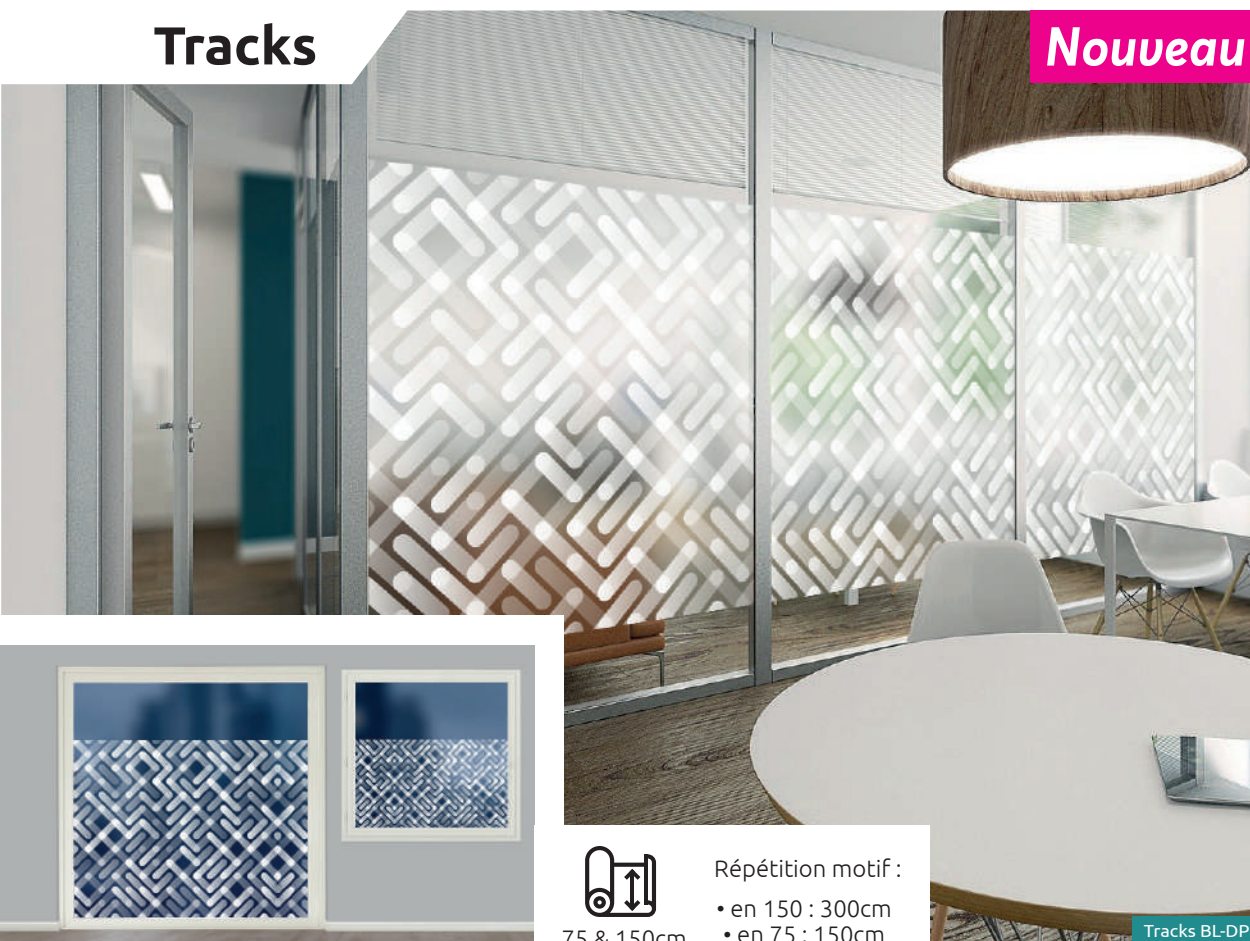

75 & 150cm

Répétition motif :

- en 150 : 300cm
- en 75 : 150cm

Tracks BL-DP

FOND DÉPOLI : OCCULTATION TOTALE

Tracks NO-DP

Tracks BL-DP

FOND TRANSPARENT : SEMI OCCULTATION

Tracks DP-TR

Tracks NO-TR

Tracks BL-TR

Les « Excellence » : Motifs Abstraites

Aurore

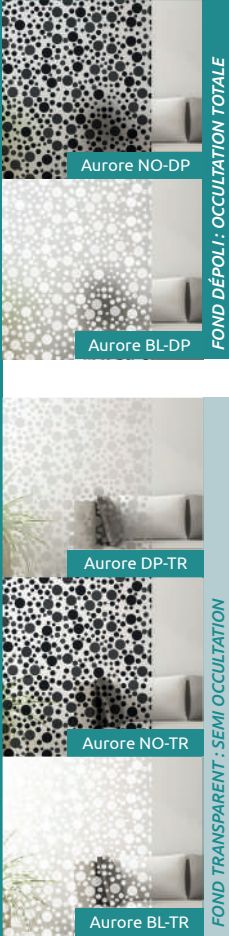

FOND DÉPOLI : OCCULTATION TOTALE

FOND TRANSPARENT : SEMI OCCULTATION



Aurore BL-TR



75 & 150cm

Répétition motif :

- en 150 : 129cm
- en 75 : 64.5cm



Nouveau

Primal

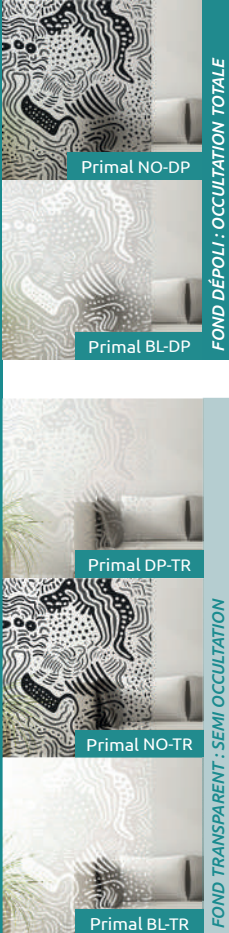

FOND DÉPOLI : OCCULTATION TOTALE

FOND TRANSPARENT : SEMI OCCULTATION



Primal BL-DP



75 & 150cm

Répétition motif :

- en 150 : 300cm
- en 75 : 150cm



Neige



75 & 150cm

Répétition motif :

- en 150 : 150cm
- en 75 : 75cm

Neige BL-TR

FOND DÉPOLI : OCCULTATION TOTALE

Neige NO-DP

Neige BL-DP

FOND TRANSPARENT : SEMI OCCULTATION

Neige DP-TR

Neige NO-TR

Neige BL-TR

Trippy

Nouveau



75 & 150cm

Répétition motif :

- en 150 : 225cm
- en 75 : 112.5cm

Trippy BL-TR

FOND DÉPOLI : OCCULTATION TOTALE

Trippy NO-DP

Trippy BL-DP

FOND TRANSPARENT : SEMI OCCULTATION

Trippy DP-TR

Trippy NO-TR

Trippy BL-TR

Les « Excellence » : Motifs Abstrait

Gosen

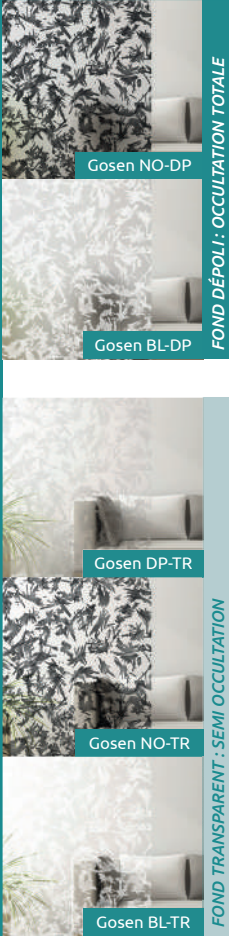

FOND DÉPOLI : OCCULTATION TOTALE

FOND TRANSPARENT : SEMI OCCULTATION



 Répétition motif :
 • en 150 : 150cm
 • en 75 : 75cm

Nouveau

Grunge

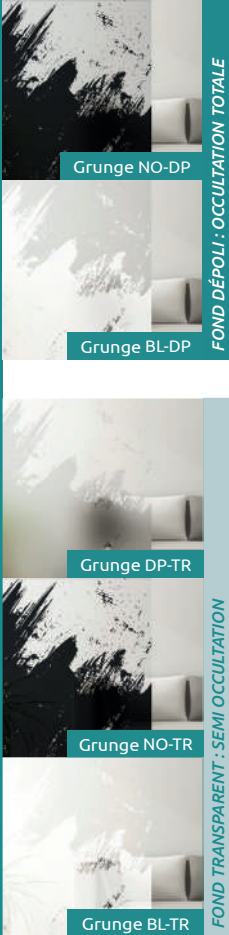

FOND DÉPOLI : OCCULTATION TOTALE

FOND TRANSPARENT : SEMI OCCULTATION



 Répétition motif :
 • en 150 : 300cm
 • en 75 : 150cm



Haie

Nouveau



75 & 150cm

Répétition motif :

- en 150 : 75cm
- en 75 : 37.5cm

Haie NO-TR

FOND DÉPOLI : OCCULTATION TOTALE



Haie NO-DP



Haie BL-DP

FOND TRANSPARENT : SEMI OCCULTATION



Haie DP-TR



Haie NO-TR



Haie BL-TR

Rotin

Nouveau



75 & 150cm

Répétition motif :

- en 150 : 225cm
- en 75 : 112.5cm

Rotin BL-TR

FOND DÉPOLI : OCCULTATION TOTALE



Rotin NO-DP



Rotin BL-DP

FOND TRANSPARENT : SEMI OCCULTATION



Rotin DP-TR

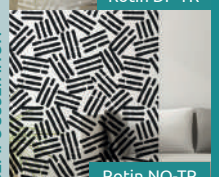

Rotin NO-TR



Rotin BL-TR

Les « Excellence » : Motifs Abstraites



Turing NO-DP

Turing BL-DP

FOND DÉPOLI : OCCULTATION TOTALE



Turing DP-TR

Turing NO-TR

FOND TRANSPARENT : SEMI OCCULTATION



Turing BL-TR

Nouveau

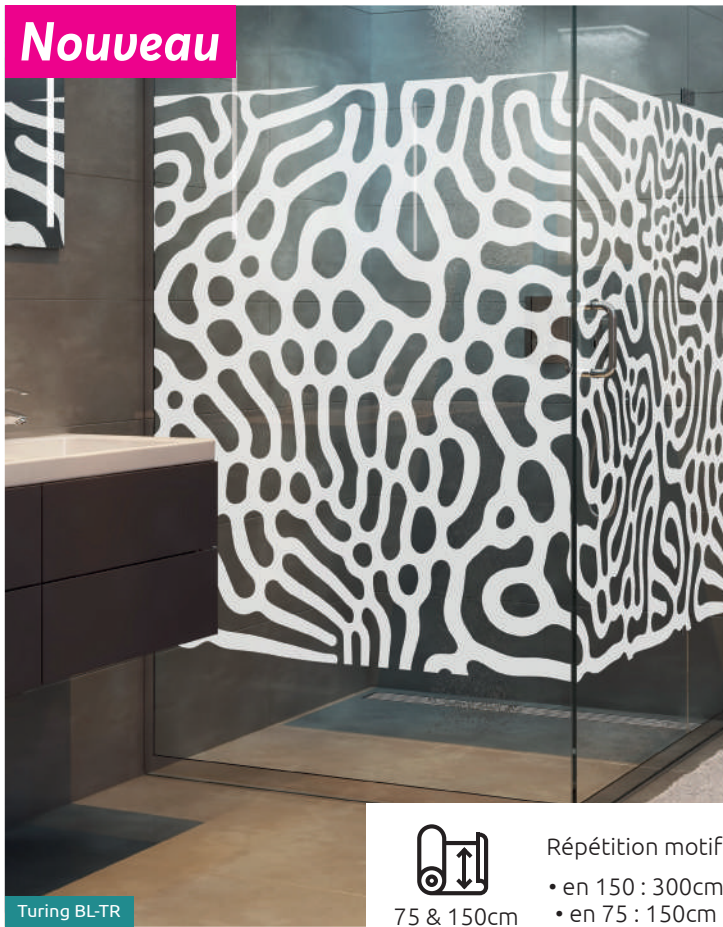

Turing BL-TR



75 & 150cm

Répétition motif :

- en 150 : 300cm
- en 75 : 150cm

Turing



Champagne NO-DP

Champagne BL-DP

FOND DÉPOLI : OCCULTATION TOTALE



Champagne DP-TR

Champagne NO-TR

FOND TRANSPARENT : SEMI OCCULTATION



Champagne BL-TR

Nouveau



Champagne BL-TR



75 & 150cm

Répétition motif :

- en 150 : 51cm
- en 75 : 25.5cm

Champagne

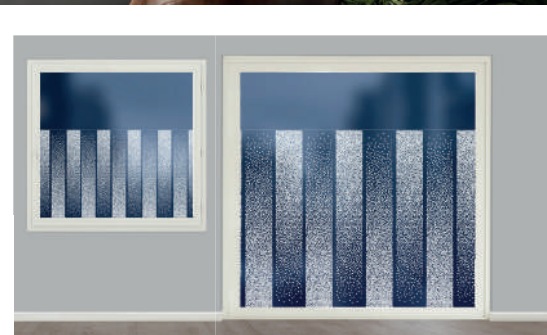

Univers



Répétition motif :
 • en 150 : 270cm
 • en 75 : 135cm

Univers NO-DP



Prime

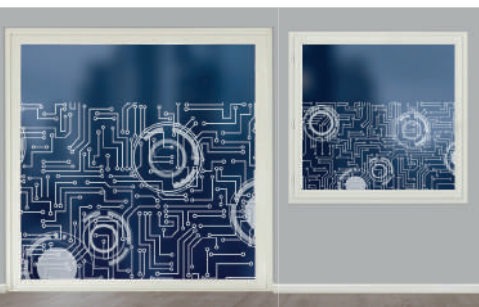
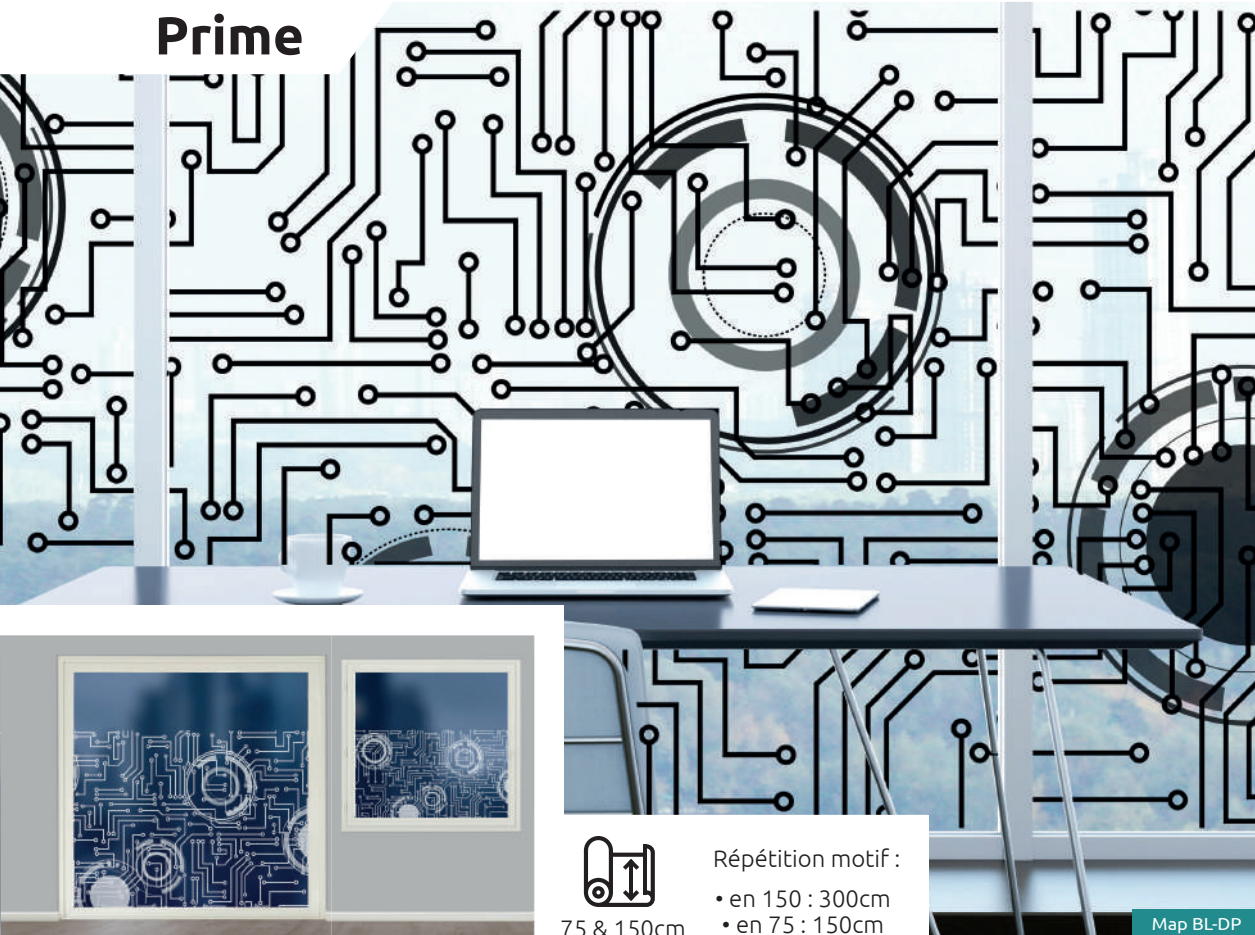

Répétition motif :
 • en 150 : 300cm
 • en 75 : 150cm

Map BL-DP



Les « Excellence » : Motifs Abstracts & Techniques

City

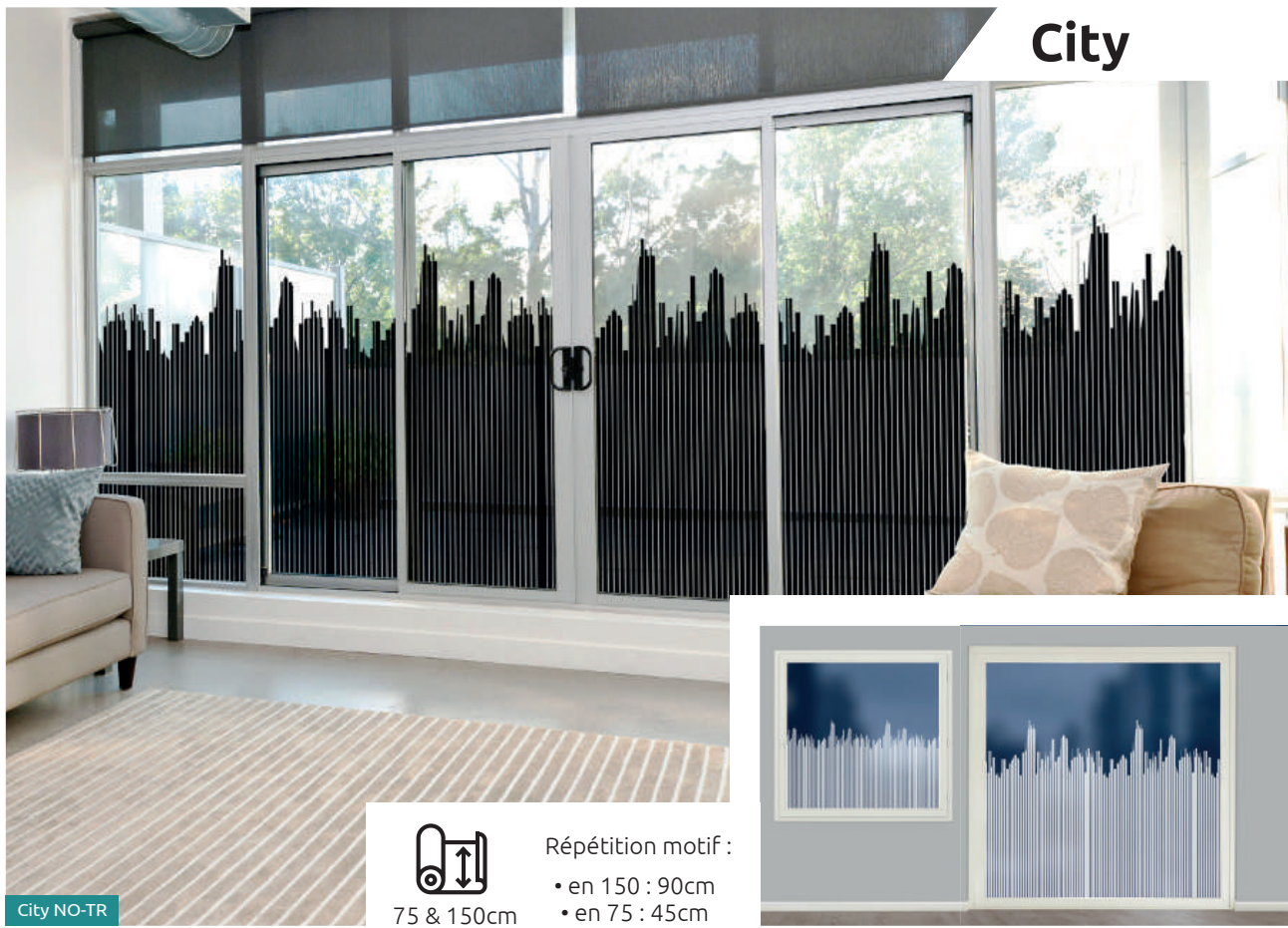

Map



Alvéol

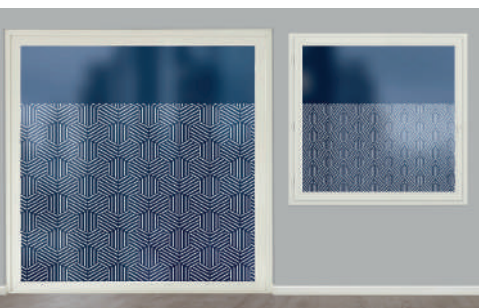

Répétition motif :

- en 150 : 54cm
- en 75 : 27cm

75 & 150cm

Alvéol BL-TR



Ardeko

Nouveau

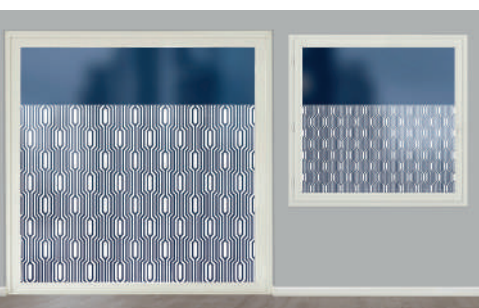

Répétition motif :

- en 150 : 25cm
- en 75 : 12.5cm

75 & 150cm

Ardeko BL-TR



Les « Excellence » : Motifs Urbains & Géométriques

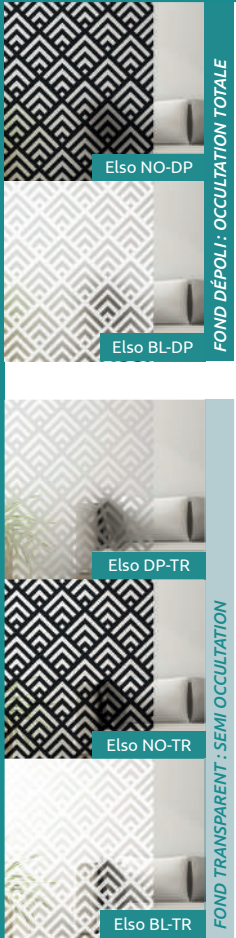

Elso



75 & 150cm

Répétition motif :

- en 150 : 26cm
- en 75 : 13cm

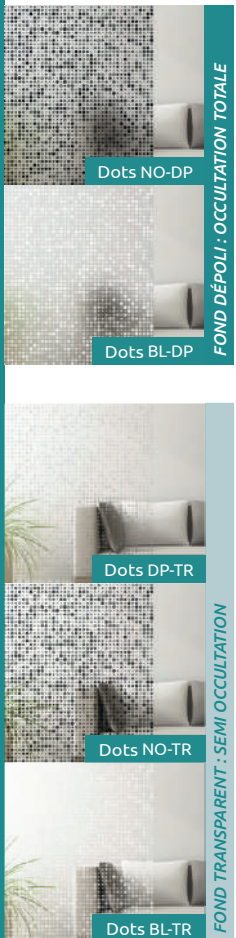

Nouveau



Dots



75 & 150cm

Répétition motif :

- en 150 : 300cm
- en 75 : 150cm

Liséa



Répétition motif :
 • en 150 : 33cm
 • en 75 : 16.5cm

Liséa DP-TR



Stars

Nouveau

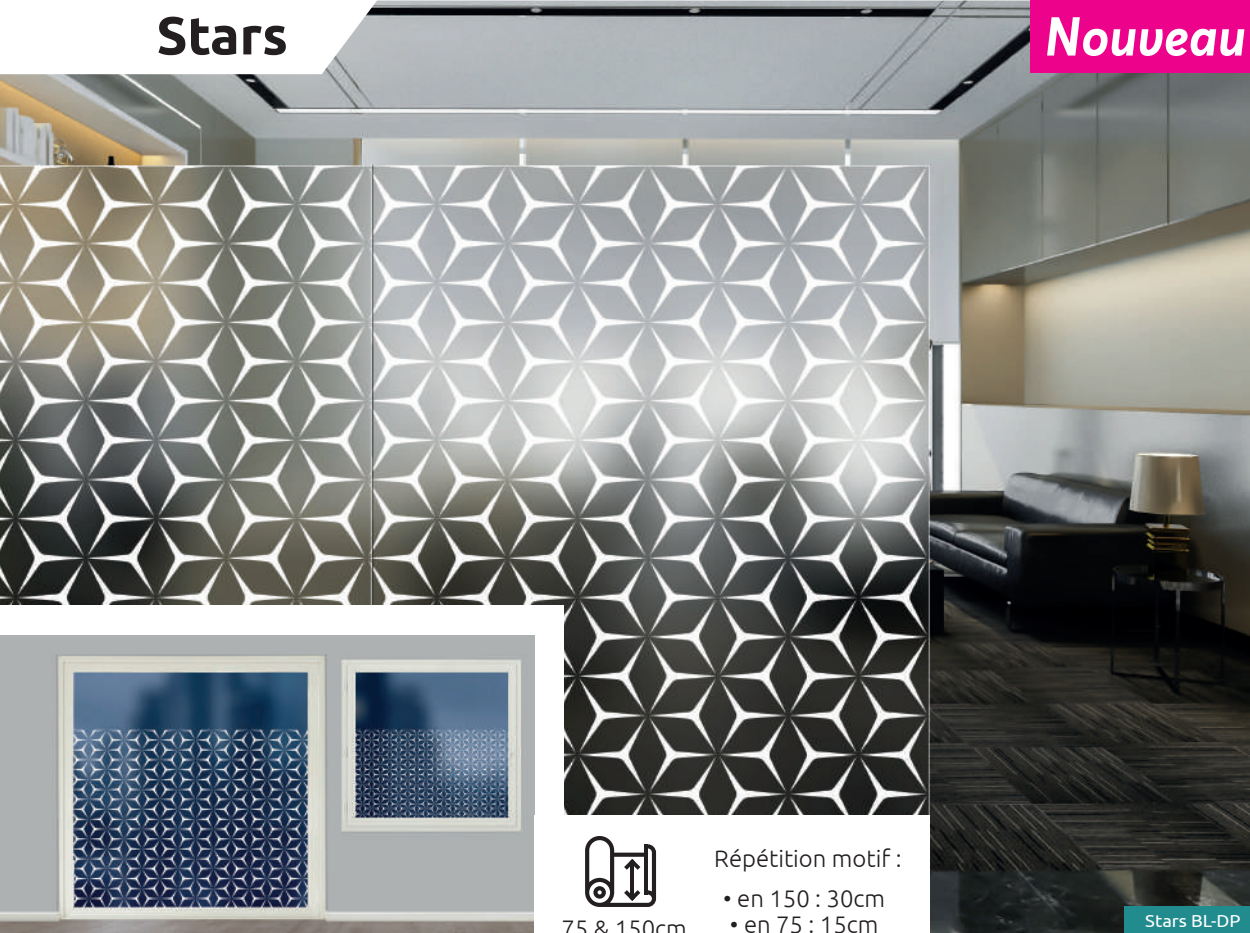

Répétition motif :
 • en 150 : 30cm
 • en 75 : 15cm

Stars BL-DP

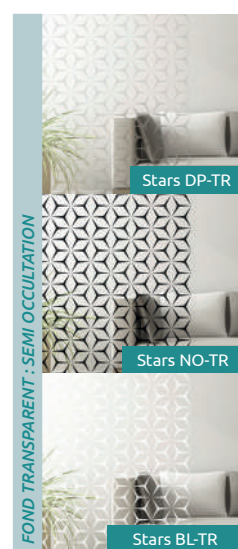

Les « Excellence » : Motifs Géométriques

Cubic

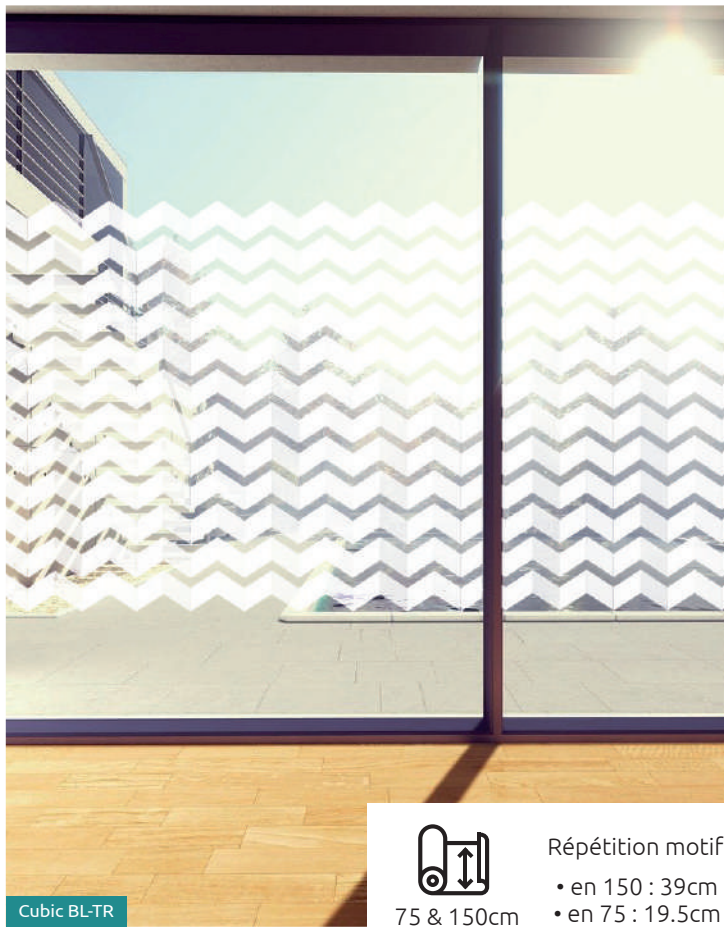
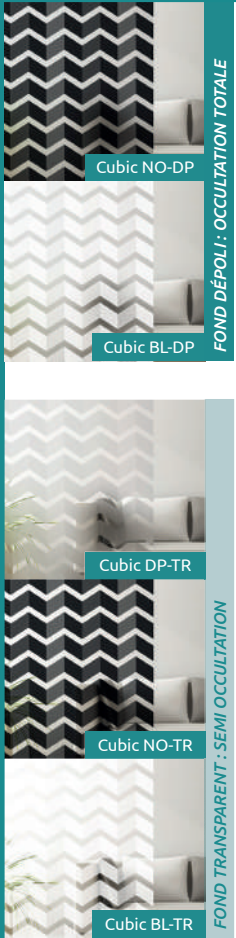

75 & 150cm

Répétition motif :

- en 150 : 39cm
- en 75 : 19.5cm

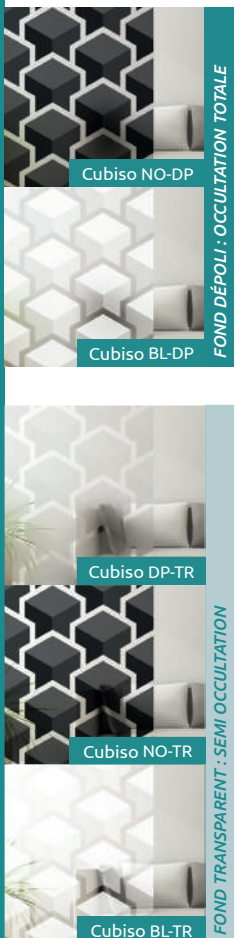

75 & 150cm

Répétition motif :

- en 150 : 38cm
- en 75 : 19cm

Cubiso



Prisme

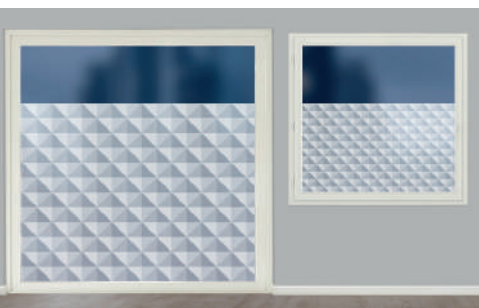

75 & 150cm

Répétition motif :

- en 150 : 54cm
- en 75 : 27cm

Prisme BL-TR

FOND DÉPOLI : OCCULTATION TOTALE

Prisme NO-DP

Prisme BL-DP

FOND TRANSPARENT : SEMI OCCULTATION

Prisme DP-TR

Prisme NO-TR

Prisme BL-TR

Gélule

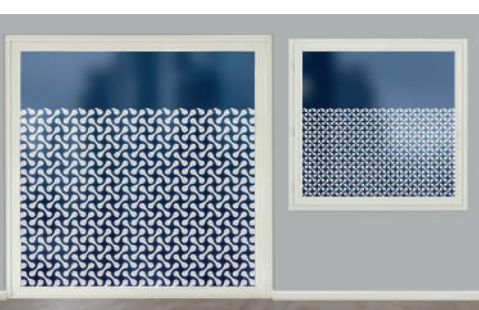

75 & 150cm

Répétition motif :

- en 150 : 25cm
- en 75 : 12.5cm

Gélule BL-TR

FOND DÉPOLI : OCCULTATION TOTALE

Gélule NO-DP

Gélule BL-DP

FOND TRANSPARENT : SEMI OCCULTATION

Gélule DP-TR

Gélule NO-TR

Gélule BL-TR

Les « Excellence » : Motifs Géométriques

Hexagone

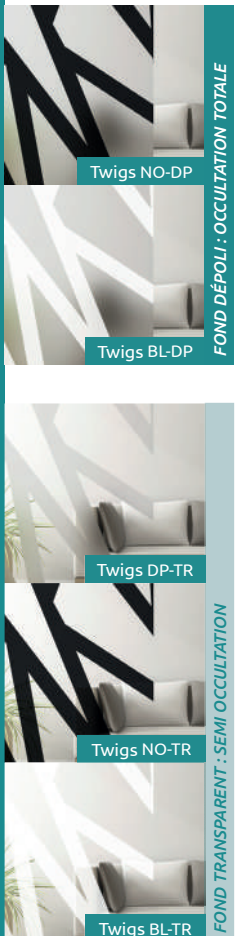

Twigs

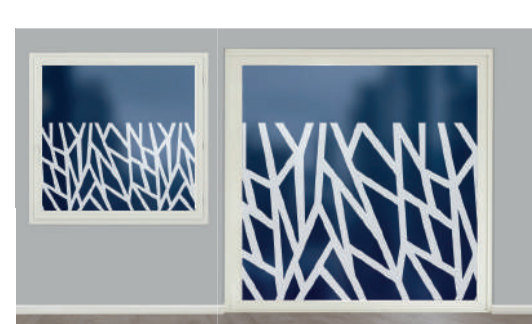

Brisé

Nouveau



Répétition motif :
 • en 150 : 150cm
 • en 75 : 75cm

Brisé NO-DP

FOND DÉPOLI : OCCULTATION TOTALE

Brisé NO-DP

Brisé BL-DP

FOND TRANSPARENT : SEMI OCCULTATION

Brisé DP-TR

Brisé NO-TR

Brisé BL-TR

Stylar

Nouveau

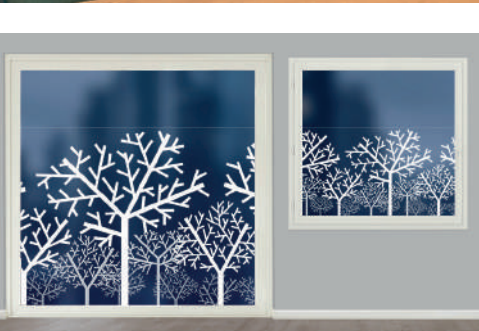
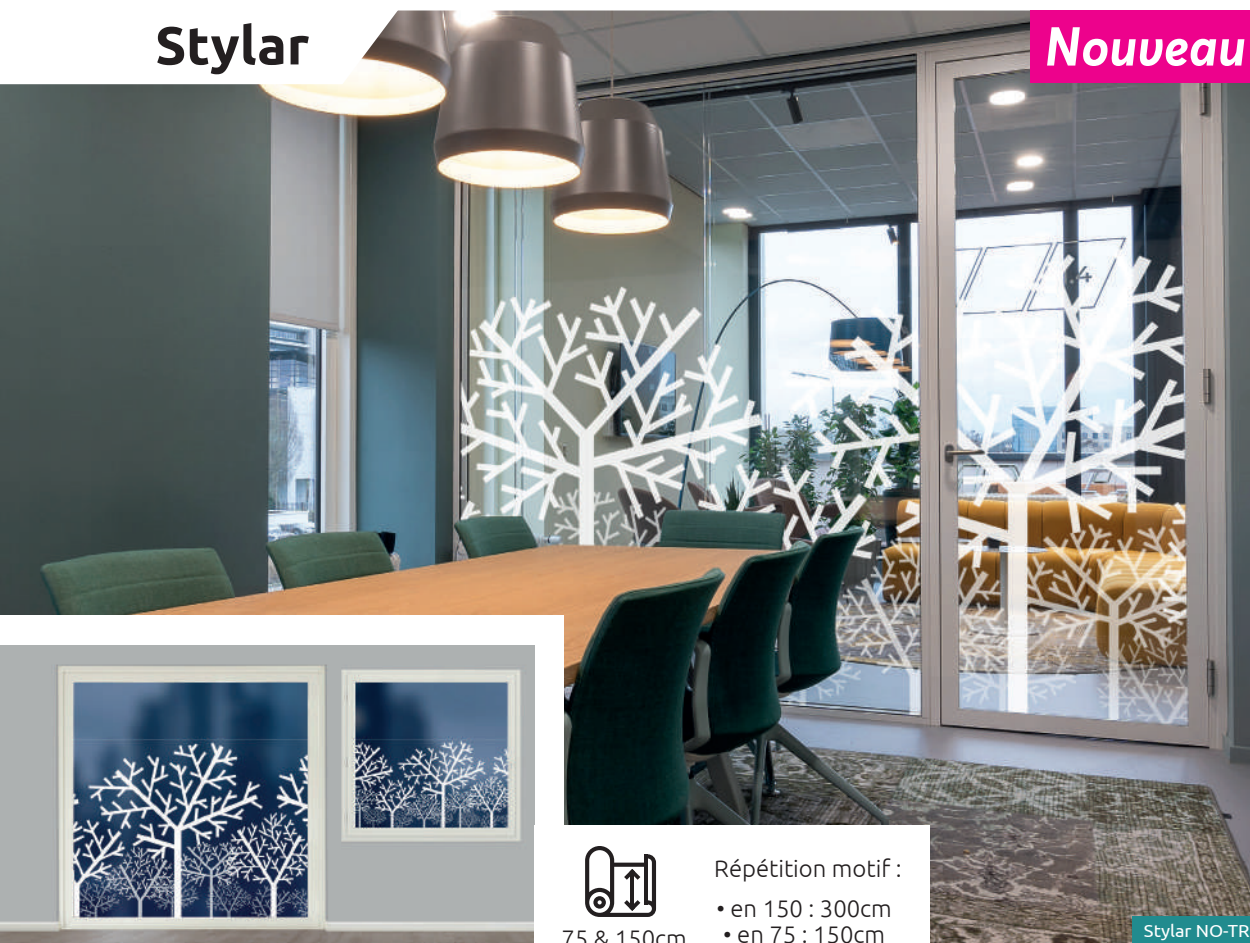

Répétition motif :
 • en 150 : 300cm
 • en 75 : 150cm

Stylar NO-TR

FOND DÉPOLI : OCCULTATION TOTALE

Stylar NO-DP

Stylar BL-DP

FOND TRANSPARENT : SEMI OCCULTATION

Stylar DP-TR

Stylar NO-TR

Stylar BL-TR

Les « Excellence » : Motifs Géométriques



Tous les motifs Carrés sont imprimés sur du film de 150cm de large.

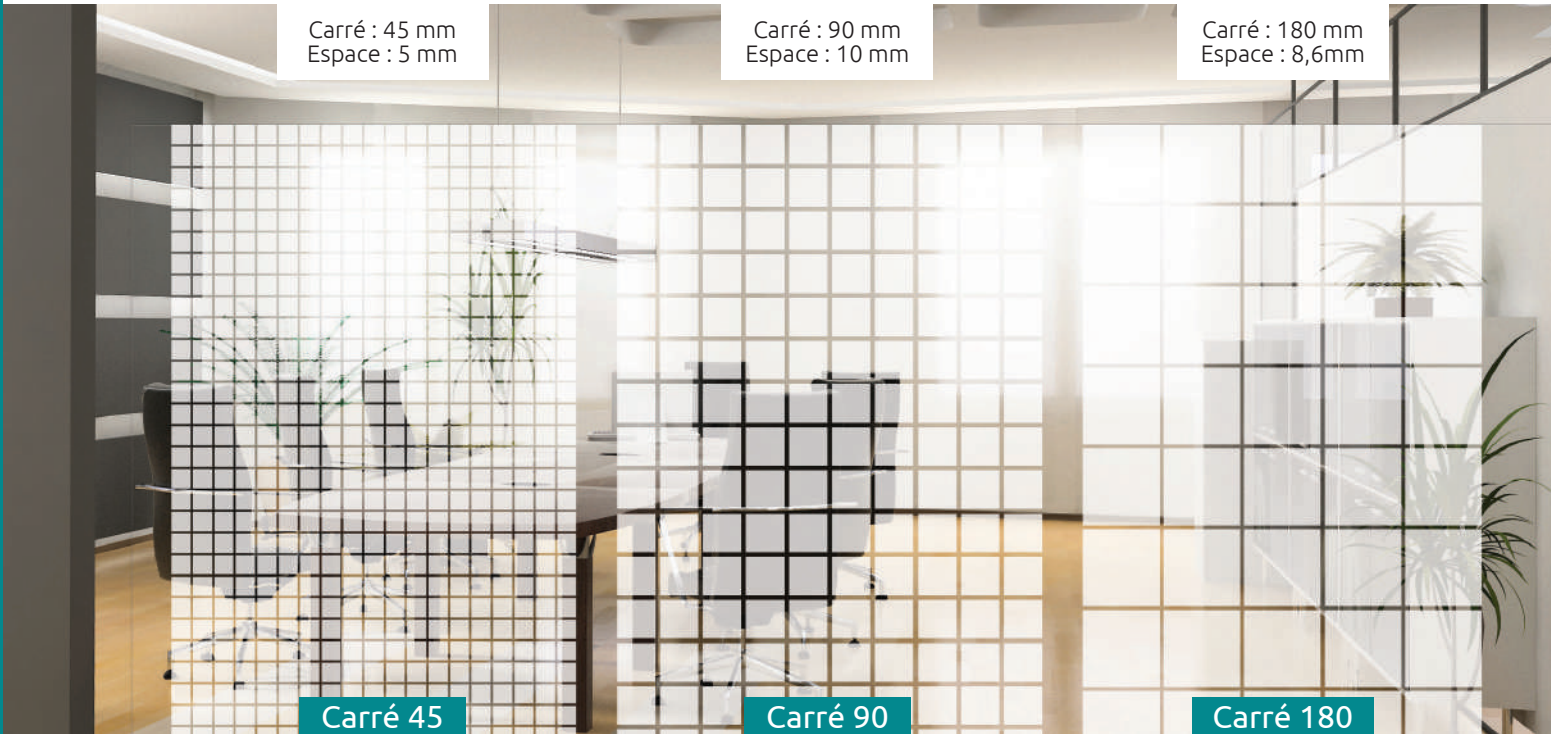

Carré : 45 mm
Espace : 5 mm

Carré : 90 mm
Espace : 10 mm

Carré : 180 mm
Espace : 8,6mm

Carré 45

Carré 90

Carré 180

Un motif très simple, avec différentes tailles, et pourtant avec la même occultation donc la même intimité. Ces modèles classiques s'intègrent dans tous vos intérieurs.

Fond transparent : semi occultant

Fond dépoli : occultation totale



Carré 45 BL-TR



Carré 45 NO-TR



Carré 45 DP-TR



Carré 45 BL-DP



Carré 45 NO-DP



Carré 90 BL-TR



Carré 90 NO-TR



Carré 90 DP-TR



Carré 90 BL-DP



Carré 90 NO-DP



Carré 180 BL-TR



Carré 180 NO-TR



Carré 180 DP-TR



Carré 180 BL-DP



Carré 180 NO-DP

Scale



Répétition motif :

- en 150 : 89cm
- en 75 : 44.5cm

75 & 150cm

Scale NO-DP



Morse



Répétition motif :

- en 150 : 363cm
- en 75 : 181.5cm

75 & 150cm

Morse NO-TR



Arcade

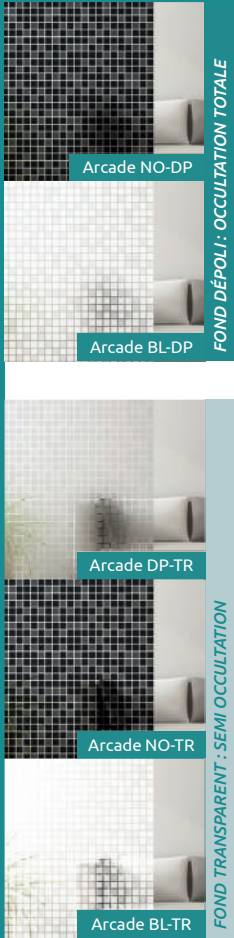

75 & 150cm

Répétition motif :

- en 150 : 68cm
- en 75 : 34cm

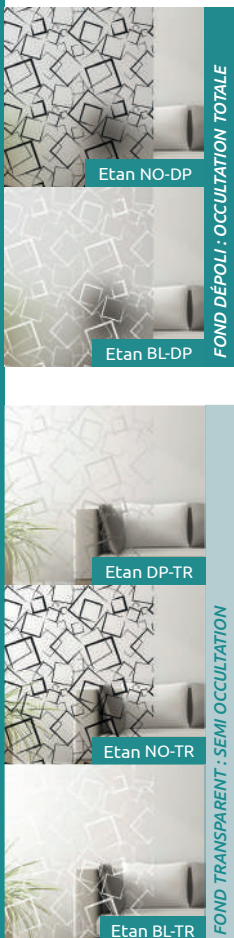

75 & 150cm

Répétition motif :

- en 150 : 37cm
- en 75 : 18.5cm



Etan



Tetroïd

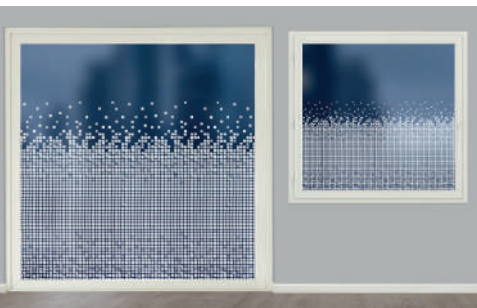

75 & 150cm

Répétition motif :

- en 150 : 89cm
- en 75 : 44.5cm

Tetroïd BL-TR

FOND DÉPOLI : OCCULTATION TOTALE



Tetroïd NO-DP



Tetroïd BL-DP

FOND TRANSPARENT : SEMI OCCULTATION



Tetroïd DP-TR



Tetroïd NO-TR



Tetroïd BL-TR

Pixels

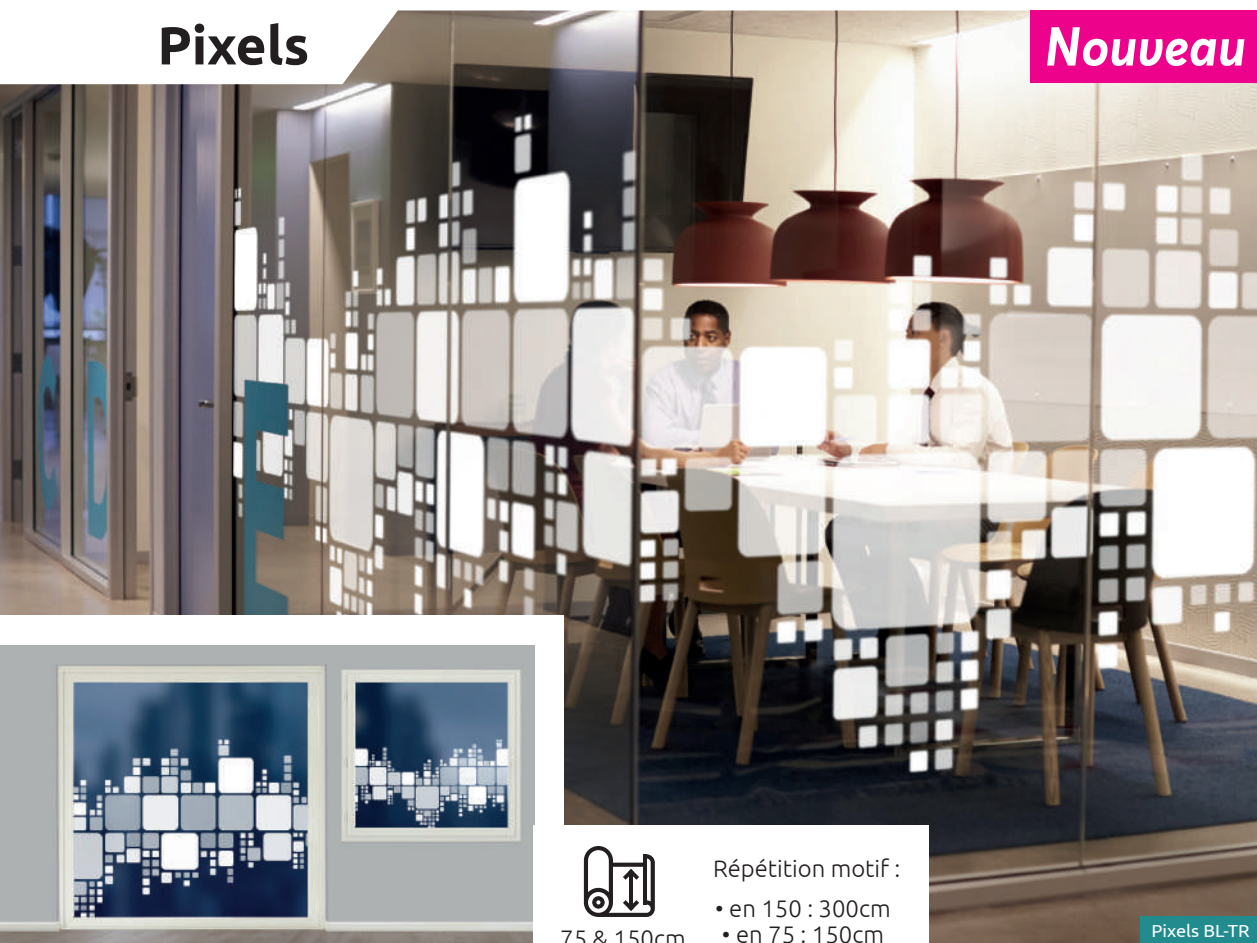

75 & 150cm

Répétition motif :

- en 150 : 300cm
- en 75 : 150cm

Pixels BL-TR

FOND DÉPOLI : OCCULTATION TOTALE



Pixels NO-DP



Pixels BL-DP

FOND TRANSPARENT : SEMI OCCULTATION



Pixels DP-TR



Pixels NO-TR



Pixels BL-TR

Les « Excellence » : Motifs Carrés



Tous les motifs **Ombrine** et les **Veni** sont imprimés sur du film de 150cm de large.



Les motifs **Ombrine** sont imprimés dans le sens de la largeur du film.

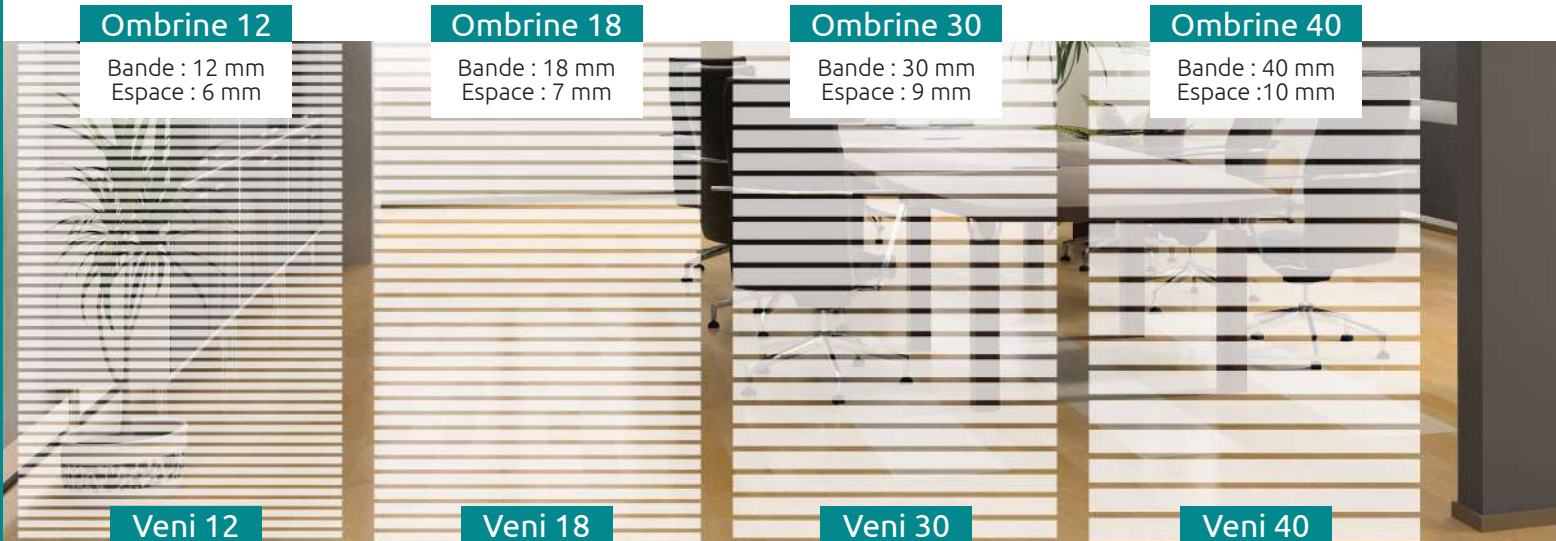

Les motifs **Veni** sont imprimés dans le sens de la longueur du film.

Fond transparent : semi occultant

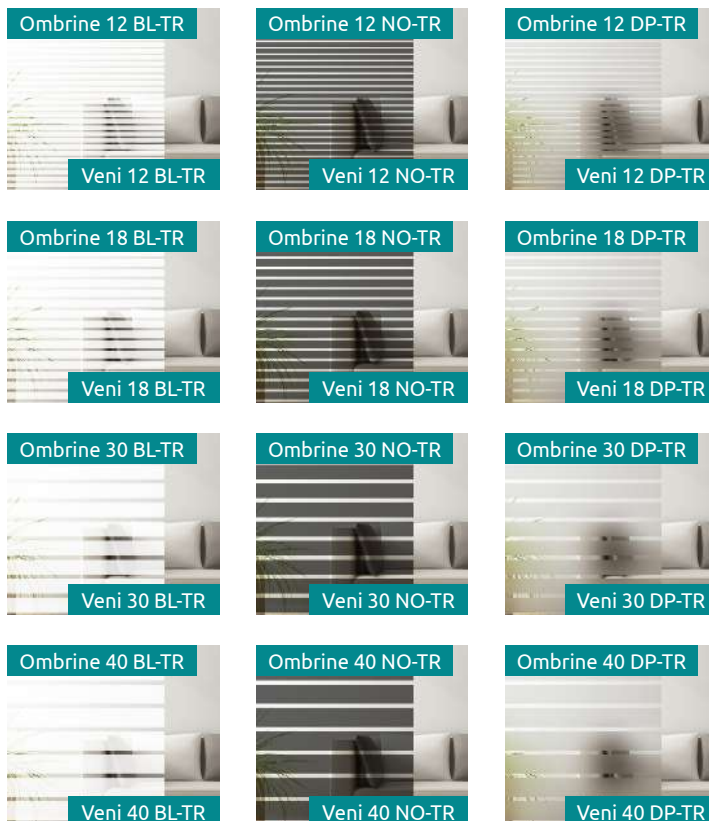

Fond dépoli : occultation totale





Veni 35-5



75 & 150cm

Bande épaisse 3.2cm
Espace 0.4 cm
Bande fine 0.4cm

Veni 35-5 BL-TR

FOND DÉPOLI : OCCULTATION TOTALE

Veni 35-5 NO-DP

Veni 35-5 BL-DP

FOND TRANSPARENT : SEMI OCCULTATION

Veni 35-5 DP-TR

Veni 35-5 NO-TR

Veni 35-5 BL-TR

Veni 40D



75 & 150cm

Largeur bande
dégressif :
4 cm

Veni 40D BL-TR

FOND DÉPOLI : OCCULTATION TOTALE

Veni 40D NO-DP

Veni 40D BL-DP

FOND TRANSPARENT : SEMI OCCULTATION

Veni 40D DP-TR

Veni 40D NO-TR

Veni 40D BL-TR

Les « Excellence »: Ombrine, Veni & Motifs Bandes

Veni BD



75 & 150cm

Largeur bande :
3,5 à 0,5 cm
Largeur espace :
0,5 à 3,5 cm

Veni BD BL-TR

Bardage

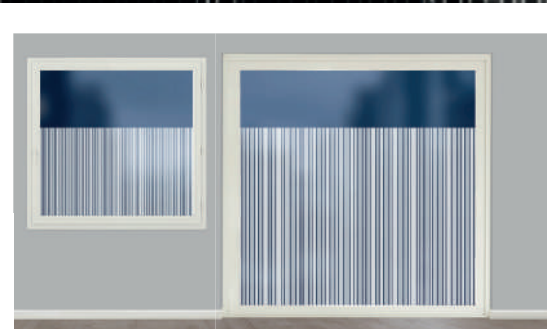
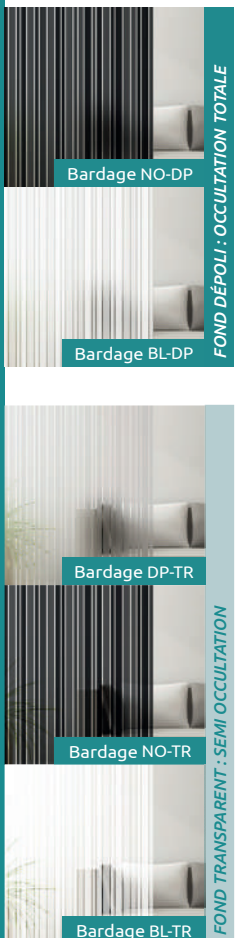

75 & 150cm

Répétition motif :
• en 150 : 180cm
• en 75 : 90cm

Bardage NO-TR



Wallas



75 & 150cm

Répétition motif :

- en 150 : 300cm
- en 75 : 150cm

Wallas NO-TR

FOND DÉPOLI : OCCULTATION TOTALE



Wallas NO-DP



Wallas BL-DP

FOND TRANSPARENT : SEMI OCCULTATION



Wallas DP-TR



Wallas NO-TR



Wallas BL-TR

Stéréo

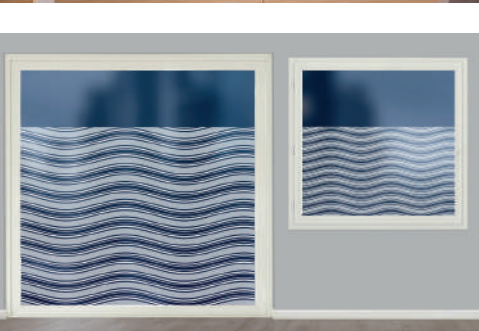

75 & 150cm

Répétition motif :

- en 150 : 100cm
- en 75 : 50cm

Stéréo BL-DP

FOND DÉPOLI : OCCULTATION TOTALE

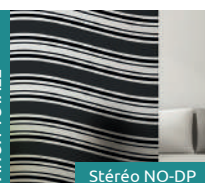

Stéréo NO-DP



Stéréo BL-DP

FOND TRANSPARENT : SEMI OCCULTATION



Stéréo DP-TR



Stéréo NO-TR



Stéréo BL-TR

Les « Excellence » : Motifs Bandes

Echo

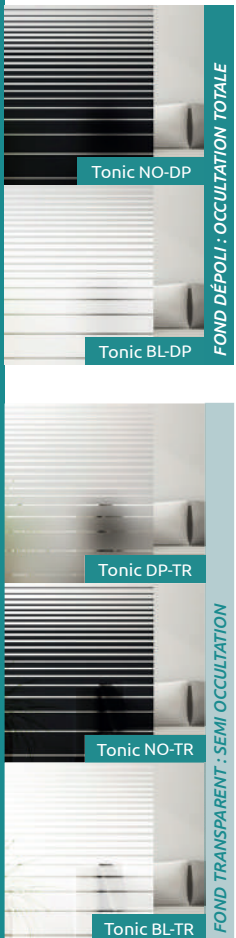
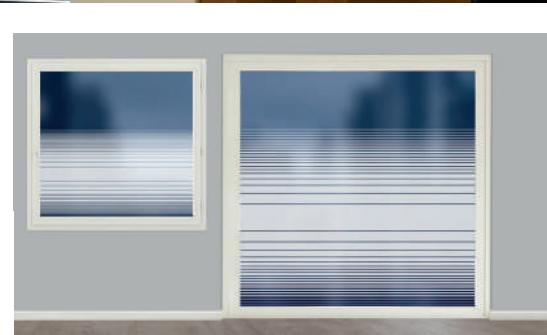
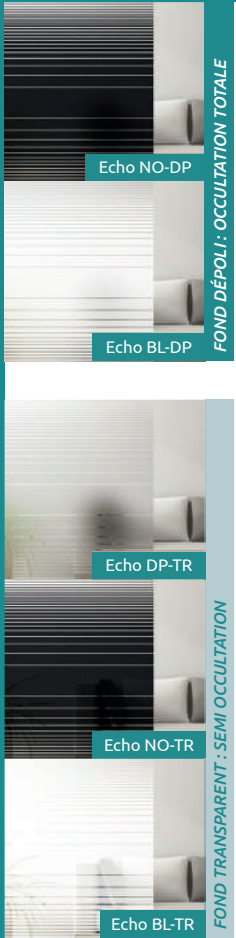

Tonic



Céleste



75 & 150cm

Répétition motif :

- en 150 : 300cm
- en 75 : 150cm

Céleste BL-TR

FOND DÉPOLI : OCCULTATION TOTALE



Céleste NO-DP



Céleste BL-DP

FOND TRANSPARENT : SEMI OCCULTATION

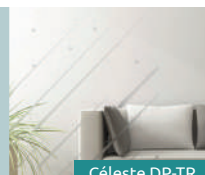

Céleste DP-TR

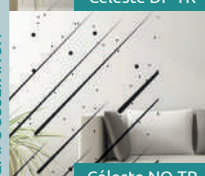

Céleste NO-TR

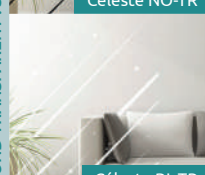

Céleste BL-TR

Highway



75 & 150cm

Répétition motif :

- en 150 : 300cm
- en 75 : 150cm

Highway NO-DP

FOND DÉPOLI : OCCULTATION TOTALE



Highway NO-DP

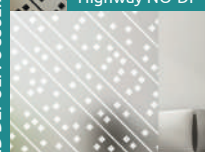

Highway BL-DP

FOND TRANSPARENT : SEMI OCCULTATION



Highway DP-TR



Highway NO-TR



Highway BL-TR

Les « Excellence » : Motifs Bandes

Nuage



FOND TRANSPARENT - SEMI OCCULTATION



75 & 150cm

Répétition motif :

- en 150 : 150cm
- en 75 : 75cm

Nuage BL-TR

London



FOND TRANSPARENT - SEMI OCCULTATION



75 & 150cm

Répétition motif :

- en 150 : 300cm
- en 75 : 150cm

London BL-TR

Horizon



 Répétition motif :
 • en 150 : 150cm
 • en 75 : 75cm

Horizon BL-TR

FOND TRANSPARENT : SEMI OCCULTATION

Horizon DP-TR

Horizon NO-TR

Horizon BL-TR

Brighton



 Répétition motif :
 • en 150 : 164cm
 • en 75 : 82cm

Brighton BL-TR

FOND TRANSPARENT : SEMI OCCULTATION

Brighton DP-TR

Brighton NO-TR

Brighton BL-TR

Les « Excellence » : Motifs Dégressifs

Impact

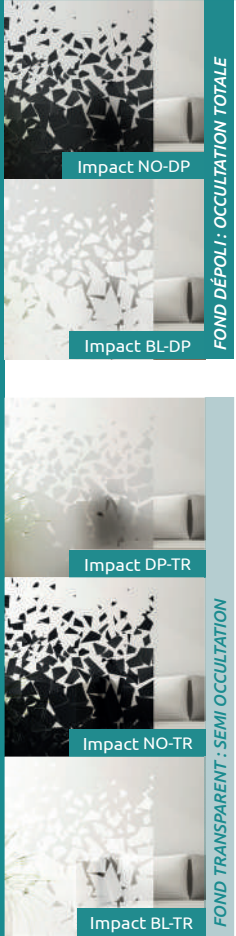

75 & 150cm

Répétition motif :

- en 150 : 300cm
- en 75 : 150cm

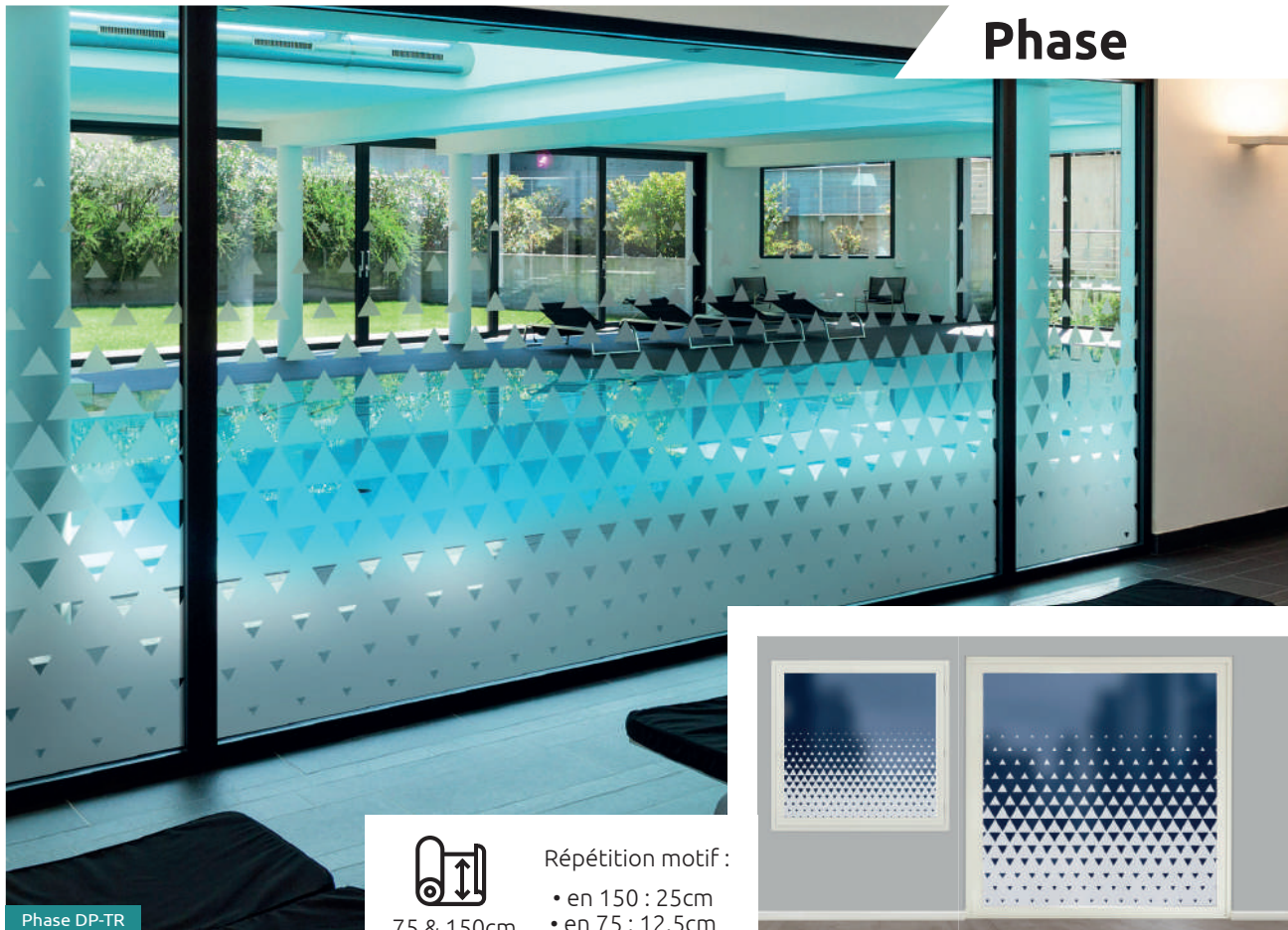
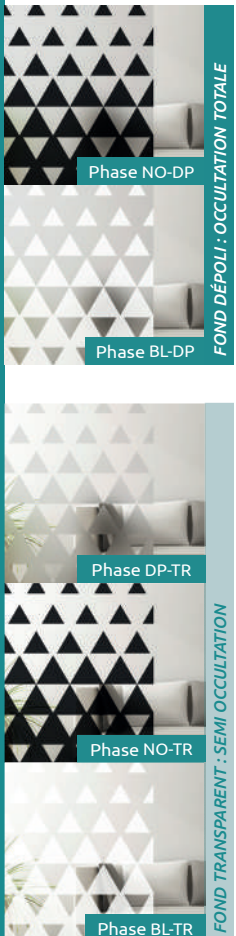

Phase



75 & 150cm

Répétition motif :

- en 150 : 25cm
- en 75 : 12.5cm

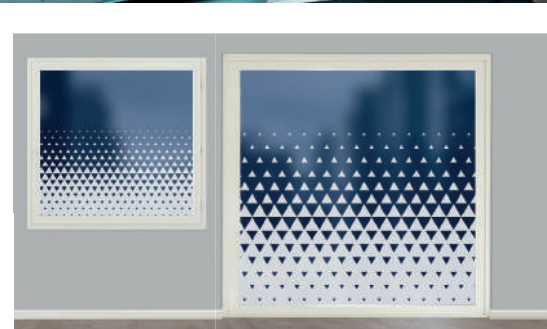

Banquise

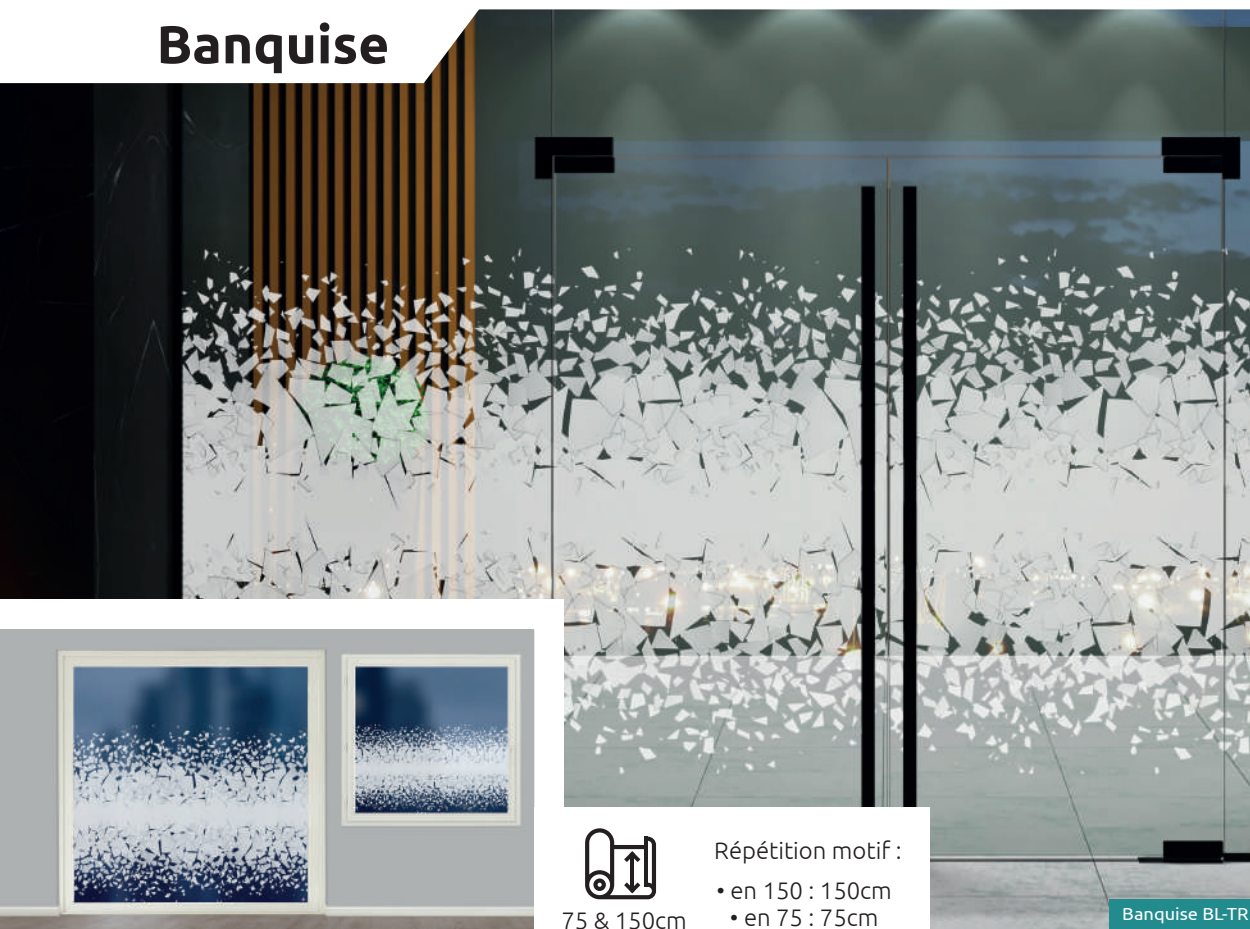

Répétition motif :
 • en 150 : 150cm
 • en 75 : 75cm

Banquise BL-TR

FOND DÉPOLI : OCCULTATION TOTALE

Banquise NO-DP

Banquise BL-DP

FOND TRANSPARENT : SEMI OCCULTATION

Banquise DP-TR

Banquise NO-TR

Banquise BL-TR

Les « Excellence » : Motifs Dégressifs

Flake



Répétition motif :
 • en 150 : 164cm
 • en 75 : 82cm

Flake BL-TR

FOND DÉPOLI : OCCULTATION TOTALE

Flake NO-DP

Flake BL-DP

FOND TRANSPARENT : SEMI OCCULTATION

Flake DP-TR

Flake NO-TR

Flake BL-TR

Everest

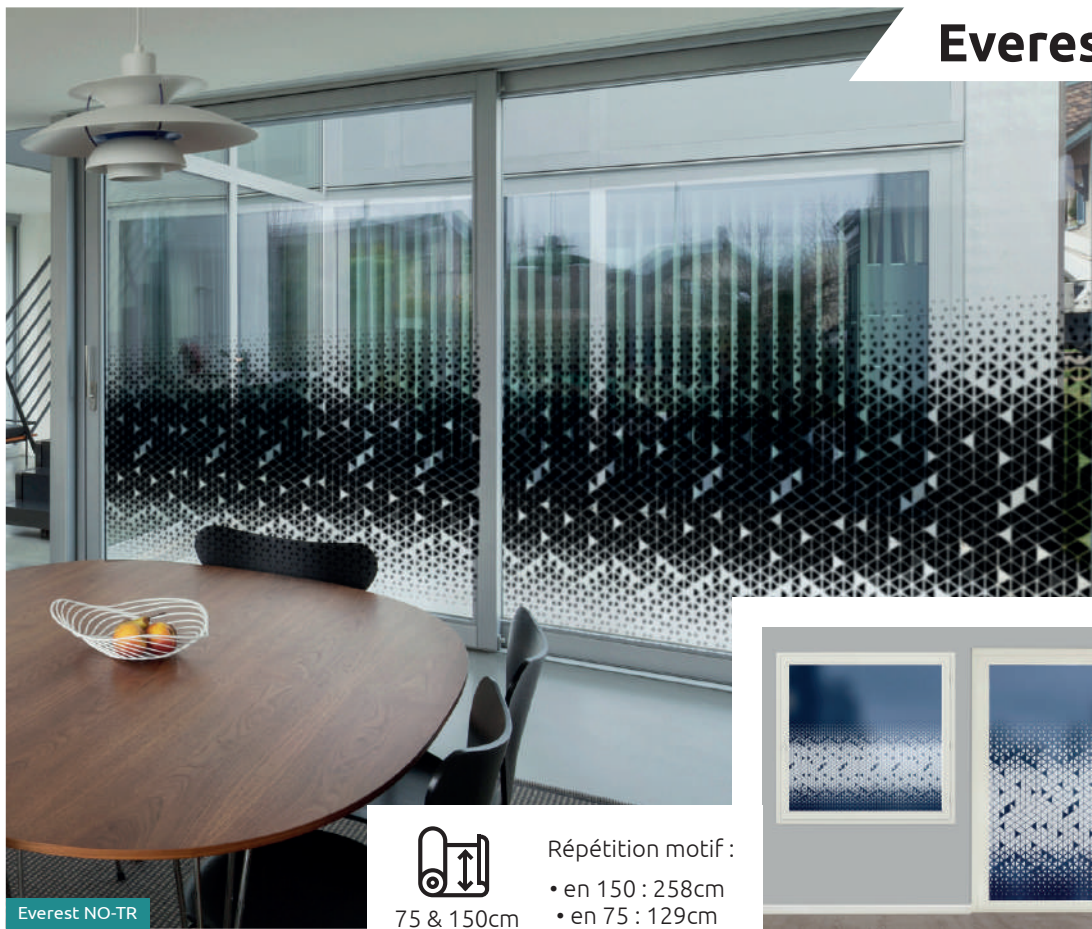
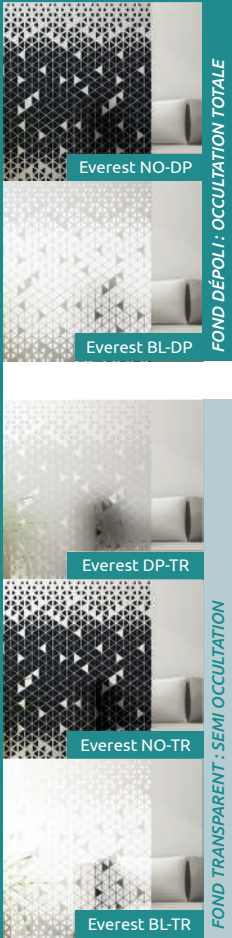

75 & 150cm

Répétition motif :

- en 150 : 258cm
- en 75 : 129cm

Nouveau

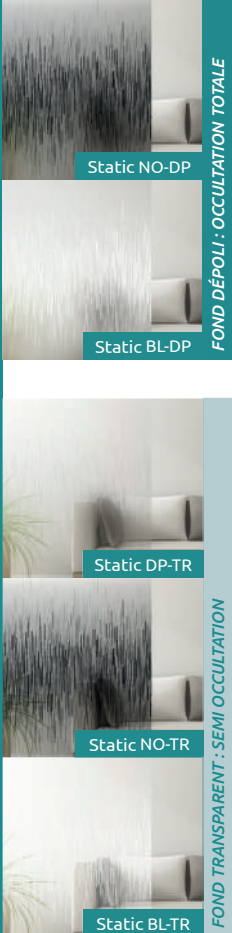

75 & 150cm

Répétition motif :

- en 150 : 150cm
- en 75 : 75cm

Static

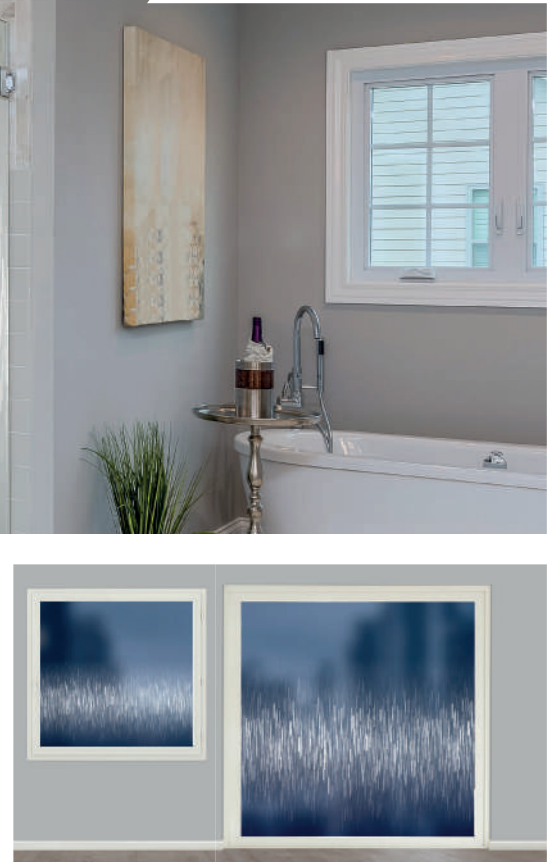

Déco Armé 13

Nouveau

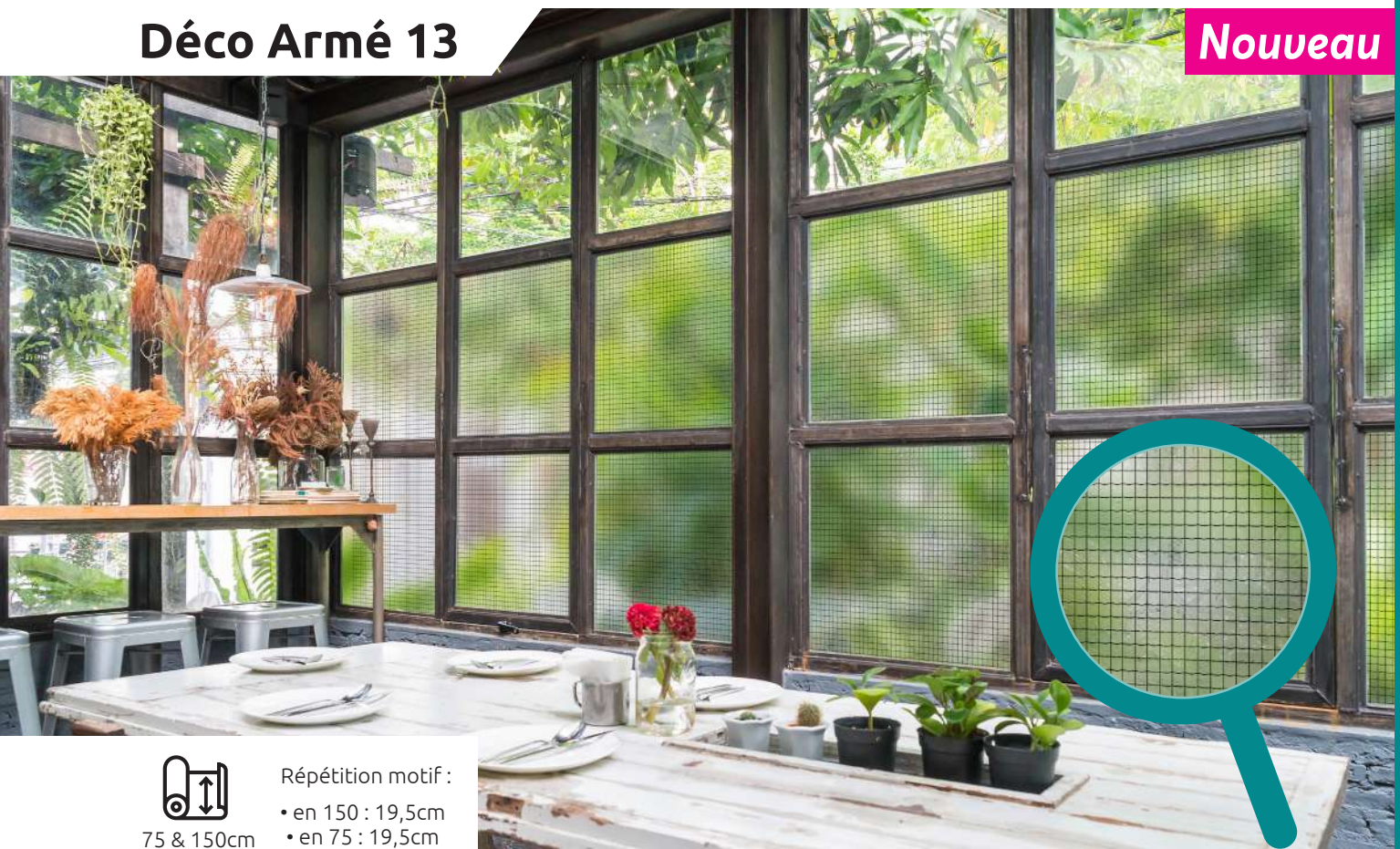

75 & 150cm

Répétition motif :

- en 150 : 19,5cm
- en 75 : 19,5cm

Déco Armé 25

Nouveau



75 & 150cm

Répétition motif :

- en 150 : 20cm
- en 75 : 20cm

Idéal



FOND DÉPOLI : OCCULTATION TOTALE

FOND TRANSPARENT : SEMI OCCULTATION



Idéal BL-DP

75 & 150cm

Répétition motif :
• en 150 : 150cm
• en 75 : 75cm

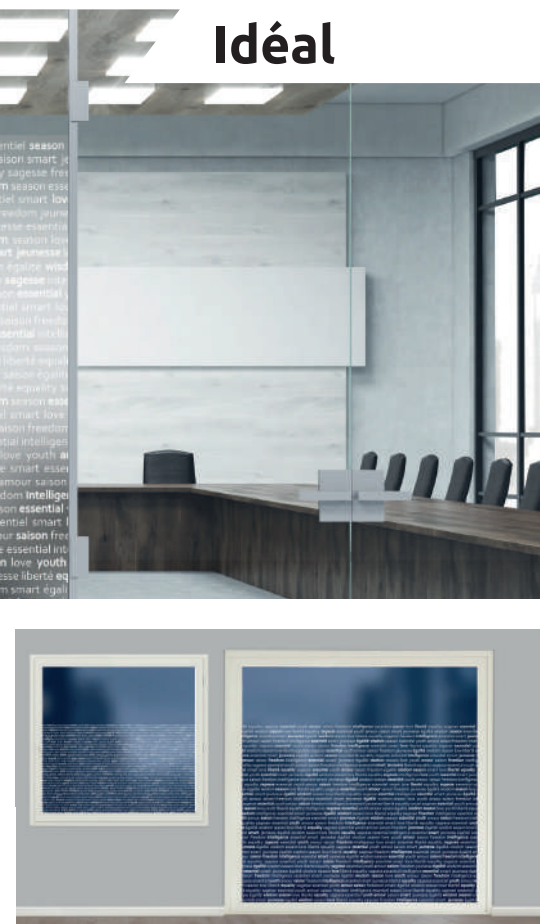

FOND DÉPOLI : OCCULTATION TOTALE

FOND TRANSPARENT : SEMI OCCULTATION



Bienvenue NO-DP

75 & 150cm

Répétition motif :
• en 150 : 300cm
• en 75 : 150cm



Au choix !

Sur film **dépoli** pour une occultation complète
Sur film **transparent** pour une semi occultation

Retrouvez le principe des films «Excellence» pour habiller :

- Fenêtres
- Portes-fenêtres
- Baies vitrées

Occultez et égayez votre vue !



Conseil de commande

Références produits :

- **Duo-F** pour les fenêtres
- **Duo-PF** pour les portes-fenêtres
- **Duo-BV** pour les baies vitrées



Avantages

- Pose intérieure
- Longévité 10 ans
- Fabrication française
- Personnalisable



Lors de votre commande, précisez **TR** pour film transparent et **DP** pour film dépoli.

Exemple : Duo-F Bucolique TR pour une fenêtre double vantaux, motif Lavande, sur film transparent.

Tous nos films sont posés à l'intérieur pour une longévité de 10 ans !

Ref : Duo-F

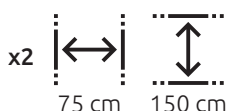

Ref : Duo-PF



Ref : Duo-BV



Nouveau

Chêne *TR ou DP*



Dimensions :

- Duo-F : x2 75x150cm
- Duo-PF : x2 75x210cm
- Duo-BV : x2 120x250cm

Nouveau

Lock *TR*



Dimensions :

- Duo-F : x2 75x150cm
- Duo-PF : x2 75x210cm
- Duo-BV : x2 120x250cm

TR ou DP **Bonsaï**

Nouveau



Dimensions :

- Duo-F : x2 75x150cm
- Duo-PF : x2 75x210cm
- Duo-BV : x2 120x250cm

Les « Excellence » : Duo Fenêtre

TR ou DP **Arches**

Nouveau



Dimensions :

- Duo-F : x2 75x150cm
- Duo-PF : x2 75x210cm
- Duo-BV : x2 120x250cm



Bucolique TR ou DP



Dimensions :

- Duo-F : x2 75x150cm
- Duo-PF : x2 75x210cm
- Duo-BV : x2 120x250cm



Coquelicot TR ou DP



Dimensions :

- Duo-F : x2 75x150cm
- Duo-PF : x2 75x210cm
- Duo-BV : x2 120x250cm

TR ou DP **Lavande**



Dimensions :

- Duo-F : x2 75x150cm
- Duo-PF : x2 75x210cm
- Duo-BV : x2 120x250cm

TR ou DP **Cosmos**



Dimensions :

- Duo-F : x2 75x150cm
- Duo-PF : x2 75x210cm
- Duo-BV : x2 120x250cm

Les « Excellence » : Duo Fenêtre



Fuji *TR ou DP*



Dimensions :

- Duo-F : x2 75x150cm
- Duo-PF : x2 75x210cm
- Duo-BV : x2 120x250cm



Vallée *TR ou DP*



Dimensions :

- Duo-F : x2 75x150cm
- Duo-PF : x2 75x210cm
- Duo-BV : x2 120x250cm

TR ou DP **Estampe**



Dimensions :

- Duo-F : x2 75x150cm
- Duo-PF : x2 75x210cm
- Duo-BV : x2 120x250cm

TR ou DP **Nova**

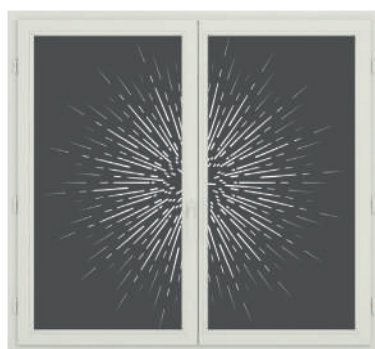

Dimensions :

- Duo-F : x2 75x150cm
- Duo-PF : x2 75x210cm
- Duo-BV : x2 120x250cm



152 cm



de 1 à 30 m

POLYESTER 50μ



Une gamme économique sur fond transparent !

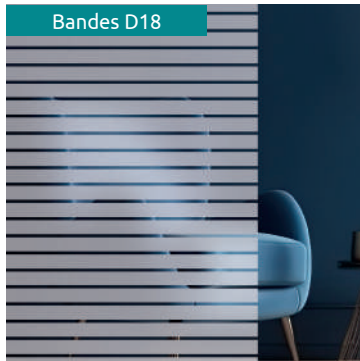

Bandes D18

Bandes dépolies de 18 mm

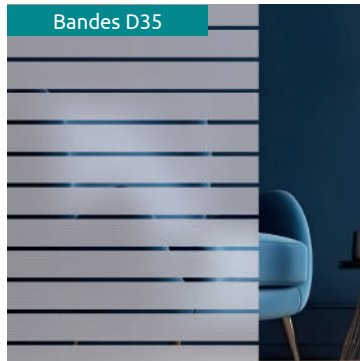

Bandes D35

Bandes dépolies de 35 mm

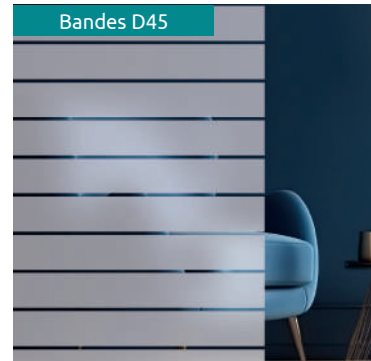

Bandes D45

Bandes dépolies de 45 mm



152 cm



de 1 à 30 m

POLYESTER 50μ



BANDES BLANCHES

Une gamme économique sur fond transparent !



Bandes B11

Bandes blanche de 11 mm



Bandes B18

Bandes blanche de 18 mm



125 cm



de 1 à 25 m

PVC 80μ



KALÉIDO

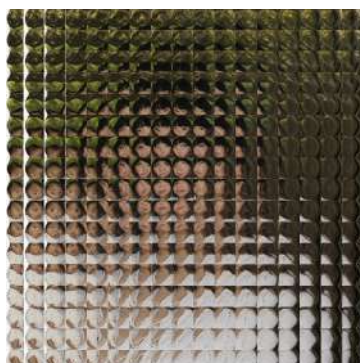











Le 1^{er} Prix

Nos films **vitrostatiques** sont **multi-repositionnables** et peuvent être **posés provisoirement** selon vos désirs. Si vous souhaitez une solution plus durable, les films adhésifs sont plus adaptés.



DEP VITRO

Film dépoli acide

 152 cm	 5 à 20 ml par tranche de 5m	+ Occultant + Enlevable
POLYESTER 100% NON FEU		
Pose sur verre et verre synthétique*		
 durabilité 3-5 ans	 courte durabilité	    

Le film dépoli acide DEP VITRO est avec un léger grain, en pose vitrostatique à l'eau savonneuse.

Occultez provisoirement les vitres de votre choix !



MIR VITRO

Film Miroir sans tain argent

 152 cm	 5 à 20 ml par tranche de 5m	+ Protège des regards + Enlevable
POLYESTER 100% NON FEU		
Pose sur verre et verre synthétique*		
 durabilité 3-5 ans	 courte durabilité	    

Le film miroir sans tain MIR VITRO vitrostatique vous permet de voir sans être vu. Du côté le plus sombre vous avez une vitre teintée, et du côté le plus lumineux vous avez un effet miroir. Pour une occultation modulable à votre guise.



VITRO 80

Film Solaire argent





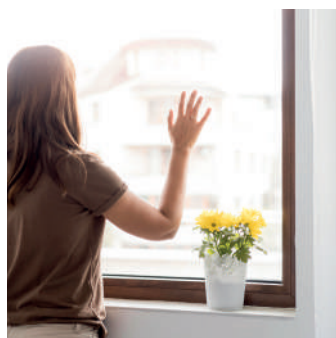



 152 cm	 5 à 20 ml par tranche de 5m	+ Efficacité + Enlevable
POLYESTER 100% NON FEU		
Pose sur verre et verre synthétique*		
 durabilité 3-5 ans	 courte durabilité	    

Le film solaire VITRO 80 vitrostatique vous permet de vous protéger de la violence du soleil l'été et de l'utiliser uniquement quand vous en avez besoin.



VITRO 50

Film Solaire argent léger

 152 cm	 5 à 20 ml par tranche de 5m	+ Luminosité + Enlevable
POLYESTER 100% NON FEU		
Pose sur verre et verre synthétique*		
 durabilité 3-5 ans	 courte durabilité	    

Le film solaire VITRO 50 vitrostatique vous permet de réduire la chaleur tout en conservant un bon niveau de luminosité. Protégez vos vitrages de façon non permanente, à votre guise !

*Toujours se référer au DTU 39

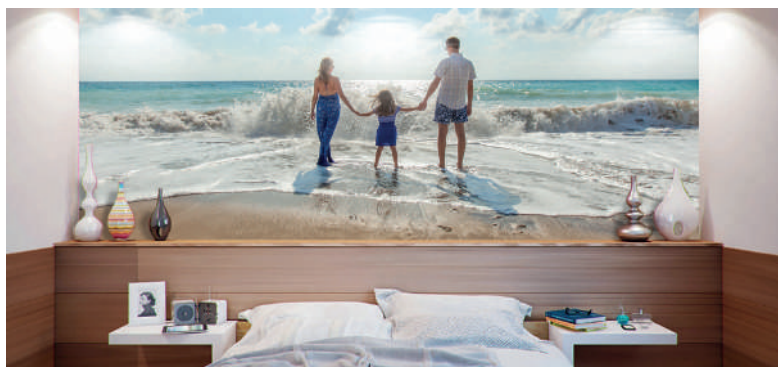

PAPIER PEINT

INTISSÉ

- Disponible sur papier peint :
 - Lisse
 - Grainé
- Sur devis



POSTER

- Disponible en plusieurs tailles
- Impression possible sur :
 - Papier
 - Papier peint
 - Film multi-repositionnable
 - Film adhésif lessivable (SUBLIM)
- Sur devis



TOILE SUR CADRE

EN BOIS

- Imprimez vos photos et visuels sur un cadre, déplacez le à votre convenance
- Disponible en plusieurs tailles
- Décore tous les intérieurs
- Sur devis



CRÉDENCE DE CUISINE

- Disponible en :
 - Verre synthétique (PMMA)
 - Aluminium composite 3mm
 - PVC 3 ou 5mm au choix
- Sur devis



PLAQUE DE PAREMENT

- Parfait pour rénover un mur ou comme paroi de douche
- Disponible en :
 - Verre synthétique (PMMA)
 - Aluminium composite 3mm
 - PVC 3 ou 5mm au choix
- Lessivable
- Sur devis



VISUEL DÉCOUPÉ

- Votre visuel/photo est imprimé puis découpé à la forme pour une intégration parfaite dans votre intérieur
- Sur devis



TAPIS PUBLICITAIRE

- Usage quotidien (feutrine)
- Epaisseur : 3 mm
- 100% polyamide
- Semelle antidérapante en PVC
- Lavable en machine jusqu'à 45°C
- Idéal pour la reproduction de photos
- Sur devis



TAPIS D'ACCUEIL

- Usage grand passage (polyester tricoté)
- Epaisseur : 6 mm
- Semelle antidérapante en caoutchouc nitrile de 1,4mm
- Impression totale en sublimation
- Sur devis



OPAC DÉCOUPÉ

- Parfait pour votre vitrophanie (texte ou visuel vectoriel)
- Plusieurs teintes disponibles (voir Films vinyles)
- Livré sous tape de transfert
- Sur devis



LETTRES DÉCOUPÉES

- Disponible en :
 - PVC de 3, 5, 10, 19 & 30mm
 - Verre composite de 3, 5 & 8mm
 - Aluminium composite de 3mm
- Options :
 - Entretoise clip
 - Éclairage LED
- Livré avec un guide de pose
- Sur devis



Accessoires pour l'application de film livrés **uniquement** avec une commande de film (PVC, plastique...).

Pose à l'eau

Pose à sec ou demi sec



BOXPRO
moyens et gros chantiers

Pose aqueuse, contient : 1 seau, 1 pulvérisateur Pro 5 L, 1 grattoir 15 cm avec 25 lames de rechange, 1 raclette de laveur de carreaux, avec caoutchouc de rechange, 1 cutter 18 mm, avec lames, 1 mouilleur, 1 guide de coupe et 50 cl de LPA.



RACPRO
dim : 25 cm

Raclette de laveur de carreaux Pro. Pour maroufler les films polyester, pour une application aqueuse sur le verre.



LPS
liquide de pose à sec
En 1 L ou en 5 L

Liquide de pose à sec à base d'alcool alcool isopropylique. A utiliser sur les surfaces bloquées et lisses pour la réduction du tack des films adhésifs.



KITPRO
moyens et petits chantiers

Pose aqueuse, contient : 1 seau, 1 pulvérisateur Pro de 2 L, 1 grattoir 15 cm, 1 raclette de laveur de carreaux, 1 cutter 18 mm, 1 guide de coupe.



RACDUR
dim : 15 cm

Raclette pour maroufler les films polyester épais. Conseillé à partir de 100µ d'épaisseur, et très fortement conseillé à partir de 200µ d'épaisseur.



RACPVC

Raclette PVC bi-face : un côté PVC & un côté velours. Pour maroufler les films vinyles, en pose à sec ou semi sec



KITPOSE
petites surfaces

Pose aqueuse, contient : 1 pulvérisateur 50 cl, 1 grattoir, 1 raclette, 1 guide de coupe et 1 cutter.



GRAT PRO
dim : 15 cm

Grattoir à vitre Professionnel large. Idéal pour la préparation des surfaces vitrées. Permet de décrocher les salissures.



CLEAN FORCE
En 1 L ou en 5 L

Nettoyant sur puissant pour dégraisser toute surface lisse. Pour le nettoyage et la préparation des supports accueillant le film adhésif. Bien rincer.



LPA
liquide de pose aqueuse
En 1 L

Liquide à diluer permettant l'application des films adhésifs pour le vitrage. Ce liquide à diluer 3% dans de l'eau. Facile la glisse du film et contient - de 5% d'agent anionique.



LAME GRAT
dim : 15 cm

Lot de 25 lames de rechanges pour le grattoir pro large. Indispensable pour la préparation des vitres avant la pose.



CLEAN POWER
Flacon de 5 cc

Liquide nettoyant spécial encres, ultra puissant. Ce nettoyant permet d'enlever de nombreuses encres (même indélébiles) sur de nombreux supports.



COLNET
Prêt à l'emploi
En 1 L

Ce liquide est un dissolvant pour les résidus de colle laissés par les films.



SCRAP VITRE
dim : 10 cm

Grattoir à vitre parfait pour la dépose des ancien films. Idéal pour la dépose des films pour vitrage, même ceux qui sont entièrement dégradé.



COUPY

Outil de découpe simple mais idéal pour la coupe de vinyles, de papiers et de films.

+ Astuce de pose

Tous ces outils sont adaptés à la pose de film d'adhésif. Optez pour un kit complet adapté pour une intervention sur vos surfaces afin de poser en toute facilité.



REGLET
• 50cm
• 100cm

Tout en acier inoxydable, il convient à vos différents travaux.



RÈGLE DE DÉCOUPE
• 100cm
• 150cm

Règle anti-dérapante pour bien plaquer vos supports, doté d'un garde doigts pour votre protection.



Vidéo de pose !

- Température de pose supérieure à 5°C.
- 24 h à 48 h après la pose : appliquer un vernis incolore (intérieur) ou silicone (extérieur) sur toute la périphérie du film afin de parfaire l'étanchéité et de conserver les garanties du produit.
- Si quelques défauts visuels subsistaient après la pose : ils disparaîtraient après 4 à 5 semaines.
- Ne pas toucher ou nettoyer le film pendant la période de séchage (4 à 5 semaines).
- Après la période de séchage : le film peut être lavé avec de l'eau légèrement savonneuse. Les produits abrasifs, à base d'alcool ou d'ammoniac sont à proscrire.
- Des bulles peuvent apparaître quelques heures ou quelques jours après la pose : ne rien faire. Ces bulles disparaîtront après la période de séchage.
- Pour la pose de tout film métallisé ou teinté foncé sur un vitrage, épais, teinté double ou feuilleté, nous consulter ou se conformer au DTU 39.



KITPOSE nécessaire

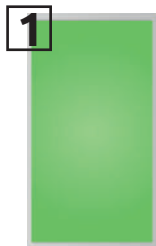

1

Pré-découper votre film quelques cm plus grand que votre vitrage.
En choisissant la Gamme ZEN, nous pouvons livrer le film déjà prédécoupé GRATUITEMENT.

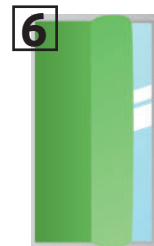

6

Retourner le film pour appliquer le côté colle contre le vitrage.
Ajuster en le faisant glisser.



2

Pulvériser du LPA et gratter votre vitrage avec le grattoir lame de rasoir.
Insister sur les bords.
Essuyer les bordures avec de l'essuie tout.

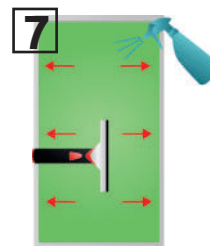

7

Pulvériser du LPA puis maroufler du milieu vers l'extérieur en commençant par le haut.



3

Pulvériser du LPA, puis passer la raclette en commençant par le haut.
Au besoin renouveler cette opération.
Essuyer à nouveau les bords.



8

Araser le film à l'aide du cutter et du guide de coupe pour laisser un joint de dilatation (1 à 2 mm).



4

Pulvériser du LPA sur le vitrage et dérouler le film côté colle vers soi.
Le côté colle se trouve généralement sur la face intérieure du rouleau.

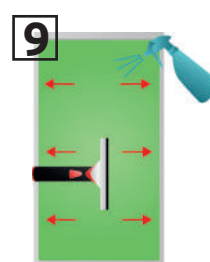

9

Pulvériser du LPA et maroufler les bords pour parfaire la finition.



5

Retirer le liner à l'aide de 2 morceaux de ruban adhésif et pulvériser le LPA abondamment en brouillard fin.



10

Essuyer les bords avec l'essuie tout pour éviter que l'eau rentre par capillarité.